



RELIABLE SAFE ACCESS

Full Height Gate Operation & Maintenance Manual





SAFETY GATES

KEE GATE is a complete range of safety gates designed specifically to provide permanent hazard protection for internal or external applications.

KEE GATE can provide permanent protection for any openings, ladder/stair access points, roof hatches and restricted areas, where regular access for maintenance & inspection is required. The gates have been specifically designed to provide a “retro-fit” solution to existing fixed structures where opening protection is required.



APPLICATION

KEE GATE Full Height Gate is designed to comply with EN 4211 : *Specification for Permanently Fixed Ladders*, which requires gates on ladders to offer the same level of protection as EN 14122 compliant guardrail. Standing at 1100mm tall and featuring an aluminium toe board, it provides additional protection to those working at any level. The gate width is fully adjustable and can accommodate openings up to 1m.

Connecting the KEE GATE to the supporting structure/post/stringer is simple and done using the U-bolt which provides connection around any flat, square or tubular stringer from 33.7 – 48.3mm (1” – 1.5”).



DURABILITY

KEE GATE is available in a range of high quality finishes. Galvanised: Components are supplied with a galvanised finish to BS EN ISO 1461 and ASTM A53: hot dip galvanised coating specification and testing methods, giving an average coating of between 55-100 microns. Powder Coated: to USA-AAMA 2603-2605, durable, polyester coating applied.

COMPONENT BASED SYSTEMS

All products consist of high quality tubing that seamlessly compliment our existing safety portfolio. KEE GATE mounts easily to all variants of the KEE KLAMP & KEEGUARD systems, as well as safe access solutions such as mobile access platforms & static access platforms.



Compliance

PRODUCT SPECIFICATION – EUROPEAN – USA - CANADIAN

FEATURES:- Spring Loaded, self-closing full height safety gate.

GENERAL

KEE GATE systems require physical fixing to the buildings structure. The complete system's design, manufacture, testing and installation have been externally assessed and tested to European – USA – Canadian Standards.

MATERIALS

European Full Height Gate

Steel tubing to EN 10255. 33.7mm diameter tube x 3.2mm wall thickness.
All steel components galvanised to BS EN ISO 1461.
All fixings are hot dipped galvanised to BS EN ISO 1461.
All cast clamps have THREDKOAT applied to all tapped holes. All grub screws are carbon steel and have KEEKOAT protection applied to ensure minimal maintenance.
Where tubing is cut on site zinc rich paint is applied to the cut end of the tube.
Powder coating to EN 13438.

USA & Canada

All steel components galvanised steel to ASTM A53.
All fixings are hot dipped galvanised to ASTM A53.
Powder coating to USA-AAMA 2603-2605.

FULL HEIGHT GATE LAYOUT EUROPE

Recommended installed height of KEE GATE is 1.1m in Europe and Canada depending on the structure it is fixed to and the national regulations. Standard gate width 1m. Internal gap between top and bottom guardrail 996mm. Top rail to mid rail centre to centre 500mm.

FULL HEIGHT GATE LAYOUT USA & CANADA

Recommended installed height of KEE GATE is 42" in the USA depending on the structure it is fixed to and the national regulations.
Standard gate width is 39.37". Internal gap between top and bottom guardrail 39.21". Top and bottom guardrail centre to centre 40.55".

TESTING

EN ISO 14122 : 2016 Part 3
EN 4211 : 2008
EN 13374 Class A
OSHA – 200 lb applied to the top rail of the gate and 150 lb on the mid-rail of the gate
ANSI – The gate must comply with the same loading requirements as the structure to which it is attached.
IBC – designed to resist linear load of 50 lb/ft
Ontario Building Code, NBC and British Columbia Building Code – Handrails and any building element that could be used as handrail shall be designed and attached in such a manner to resist, (a) a concentrated load at any point of not less than 0.9 kN (202 lb) and a uniformly distributed load of 0.7 kN/m (48 lb/ft).
OBC and NBC state – 'all other guards' – 0.75 kN/m (52 lb/ft) or concentrated load of 1.0 kN (224 lb) applied at any point on top of the guard.
Evenly distributed vertical load on top of the guard – 1.5 kN/m (103 lb/ft)
Canadian Standards Association – 0.9 kN (202 lb), 0.7 kN/m (48 lb/ft) – states 'Guard - a protective barrier around an opening in a floor or at the open side of stairs, a landing, balcony, mezzanine, gallery, raised walkway or other location; used to prevent accidental falls from one level to another; such a barrier may or may not have openings through it'.
Canada Occupational Health and Safety – 890N applied along top rail (200 lb)

LIFE CYCLE TESTING - BS 6375-2:2009 Clause 6.5 - Opening and closing of gate through 90 degrees.

SALT SPRAY TESTING - ASTM B117 - 11 - 55 over 200 hours to assess performance of coating to resist corrosion.

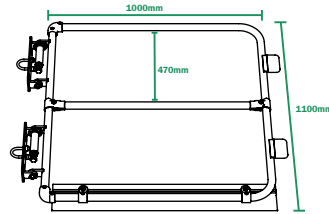

European Full Height Gate - Galvanised - SGEUFH1GV

Spring loaded, self-closing safety gate. Manufactured from steel to EN 10255. 33.7mm diameter tube x 3.2mm wall thickness to meet requirements of EN 13374 & EN 14122:2016. Complete with fixing pack.

Material : Galvanised steel to BS EN ISO 1461. Net weight : 22kg (30lb 10oz).

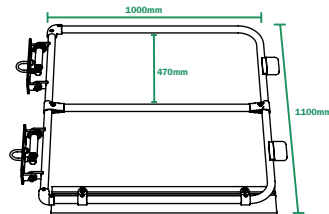
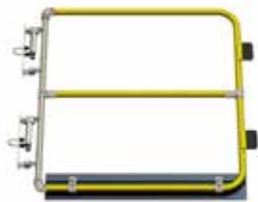

European Full Height Gate – Powder Coated - SGEUFH1PC

Spring loaded, self-closing safety gate. Manufactured from steel to EN 10255 33.7mm diameter tube x 3.2mm wall thickness to meet requirements of EN 13374 & EN 14122:2016. Complete with fixing pack. Powder coated finish to EN 13438.

Material : Steel to EN 10255. Net weight : 22kg (30lb 10oz).



SAFETY GATE EUROPEAN FIXING PACK 1 - SGEUFXPK1

Supplied for the European market to fit posts 33.7mm, 42.4mm and 48.3 mm diameter. Fixing pack contains 3No U-Bolts for each size complete with M8 and M10 nuts and washers.

Material : Galvanised steel to BS EN ISO 1461. Net weight : 0.864kg (1lb 14oz).

Note:- Installing Kee Gate

KEE GATE Full Height Gate can only be fitted on a fixed roof where the pitch of the roof will not interfere with the operation of the gate.





Full Height Gate Components - North America

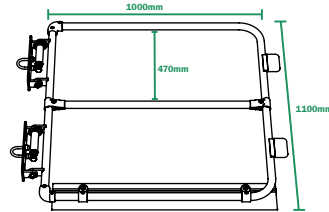

North American Full Height Gate - Galvanised - **SGNAFH1GV**

Spring loaded, self-closing safety gate. Manufactured from steel to EN 10255. 33.7mm diameter tube x 3.2mm wall thickness to meet requirements of EN 13374 & EN 14122:2016. Complete with fixing pack.

Material : Galvanised steel to BS EN ISO 1461. Net weight : 30lb 10oz.

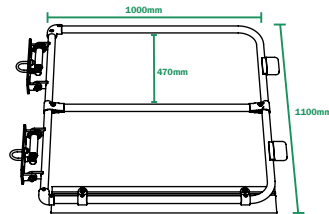
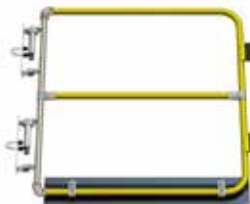

North American Full Height Gate – Powder Coated - **SGNAFH1PC**

Spring loaded, self-closing safety gate. Manufactured from steel to EN 10255 33.7mm diameter tube x 3.2mm wall thickness to meet requirements of EN 13374 & EN 14122:2016. Complete with fixing pack. Powder coated finish to EN 13438.

Material : Steel to EN 10255. Net weight : 30lb 10oz.

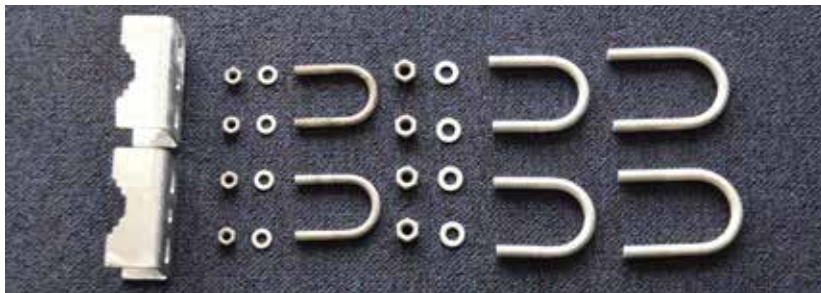

SAFETY GATE NORTH AMERICAN FIXING PACK 1 - SGNAFXPK1

Supplied for the USA market to fit posts 1.0", 1.25" and 1.5" diameter. Fixing pack contains 3No U-Bolts for each size complete with 0.3125" and 0.375" nuts and washers.

Material : Galvanised steel to ASTM A53. Net weight : 3lb 3oz (1.44kg).

Note:- Installing Kee Gate

KEE GATE Full Height Gate can only be fitted on a fixed roof where the pitch of the roof will not interfere with the operation of the gate.



TOOLS REQUIRED

You will need the following in order to install the KEE GATE:

- Marker Pen
- Tape Measure
- 1No 24mm Ring spanner
- 1No 13mm Socket
- 1No 17mm Socket
- 1No 24mm Socket
- 1No 1/4" Hex key socket
- 1No 6mm Hex key socket
- Torque wrench 10- 60 Nm approx
- Hacksaw or similar
- Small magnetic level

Mounting Gate to Upright

Establish that the gate will close in direction of hazard!!
Failure to do so could result in death or serious injury.



A. Align the upper fixing plate on internal face of the opening, so that the rails of the safety gate match up with the top of the guardrail system. Select the required size U-bolt & pass around the support leg/structure, Feed through the top holes of the fixing plate.

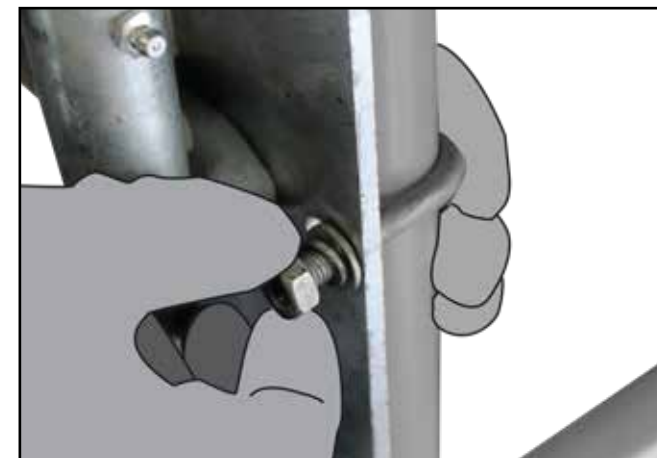

B. Using a M8 or M10 flat washer and nut connect the U-Bolt to the support leg/structure and tighten. Repeat this process for the lower fixing plate.



C. Torque all nuts/U-Bolts to 25Nm using a 13mm or 17mm socket and torque wrench.

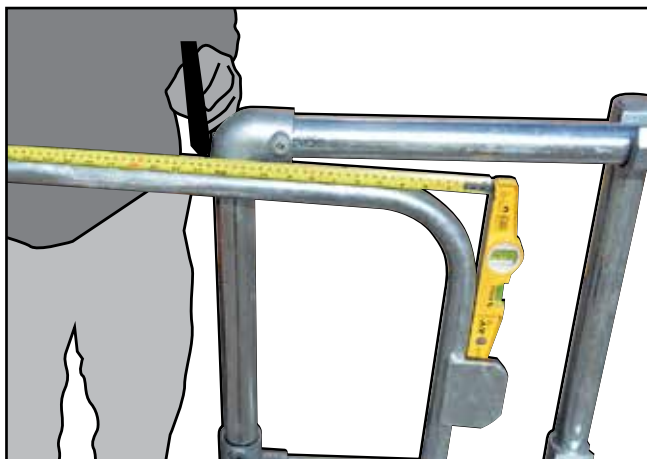

D. To cut the gate to the correct size simply place a straight edge/magnetic level as shown and measure the distance to the point where the outside edge of the vertical tube meets the supporting structure as shown. **(DO NOT CUT AT THIS MARK!)**

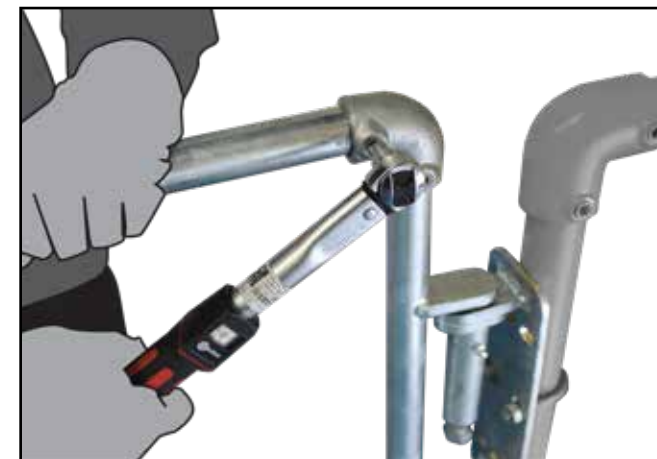

E. Disconnect the tubular gate from the hinge assembly by loosening the top & bottom cast clamp grub screw using a hex head socket as shown.

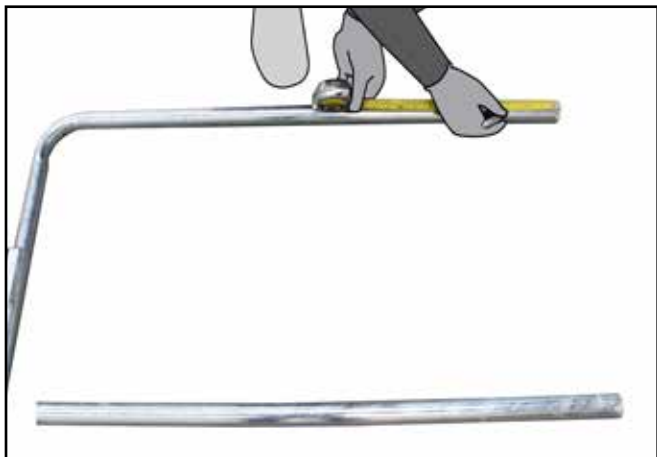

F. Measure the distance recorded in point (d) and mark the gate top and bottom tubes and mid rail as shown.

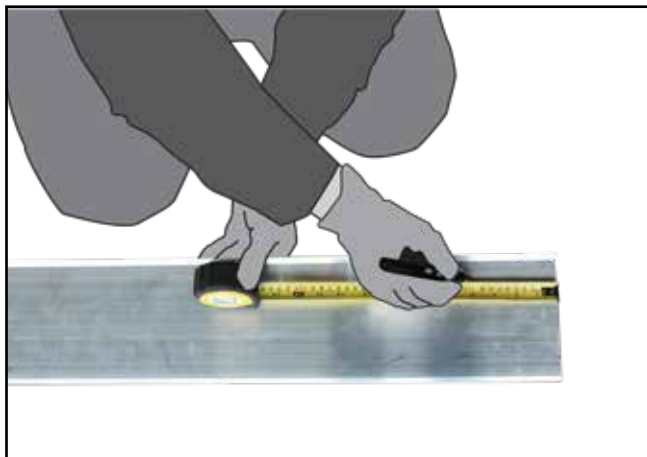

G. Measure the distance recorded in point (d) and mark the toeboard as shown.

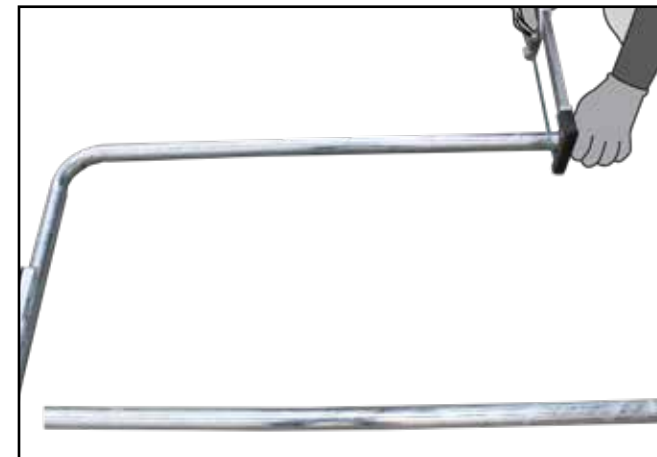

H. Using a hacksaw or similar, carefully cut through the top, bottom tubes, the toeboard and the mid rail as shown. For galvanised assemblies, spray with Galvafroid or similar to prevent corrosion.



I. Carefully re-position the gate top and bottom tubes into the cast fittings. Ensure the striking plate is on the correct side of the Support Leg/Structure. Use a spirit level to ensure the gate is level. Tighten the cast fittings grub screws using a hex head socket. Using the torque wrench ensure the castings are torqued to 39Nm.

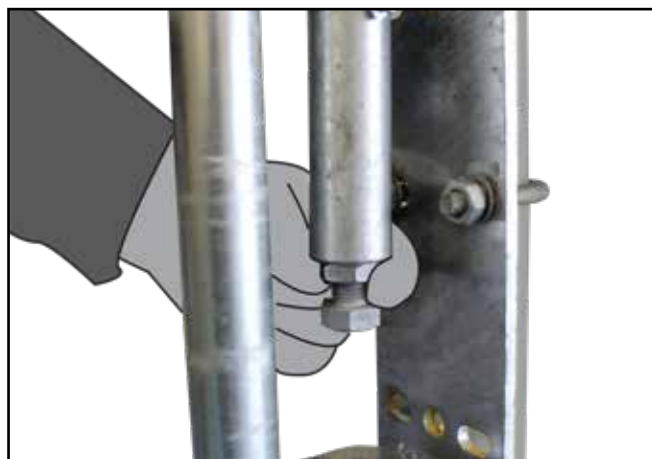

J. To tension the hinge loosen the locking nut as shown.

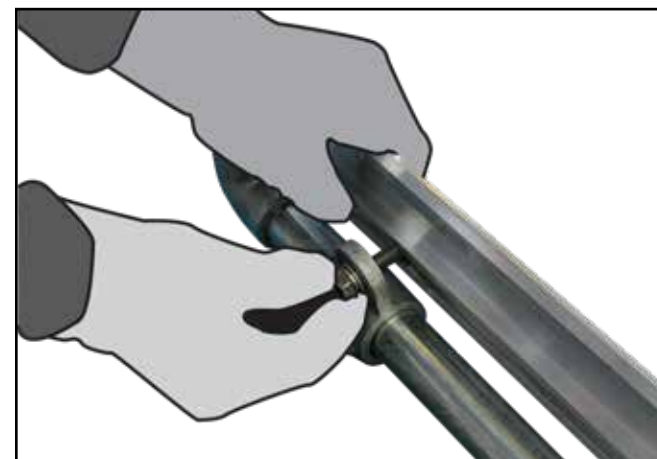

K. Use the supplied M10 nuts, bolts and spring washers to attach the toeboard to the gate.

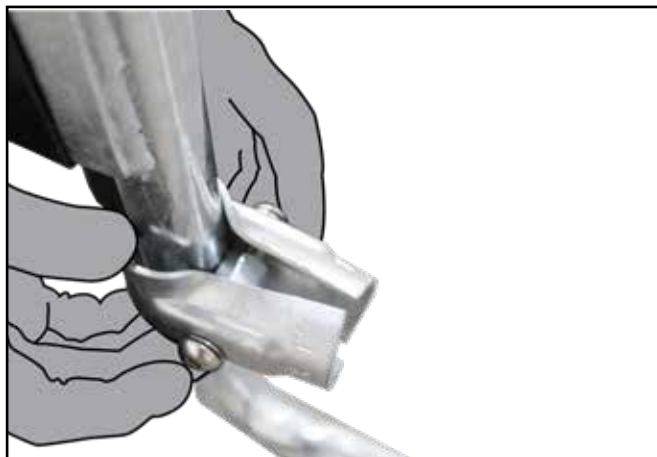

L. Mount clamp on lower part of gate, just above the bend and insert mid rail. Use 6mm hex head socket to tighten supplied M10 bolts into coupling nut.



M. Add clamp onto other end of mid rail, clamping onto the gate upright. Use 6mm hex head socket to tighten supplied M10 bolts into coupling nut.



N. Use a measuring tape to ensure gap between top rail and mid rail is no more than 470mm. Adjust if necessary.

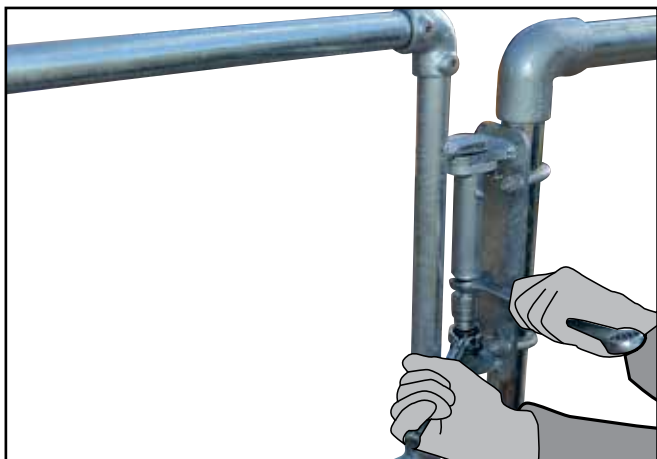

O. Loosen the locking nuts on the spring mechanisms as shown.

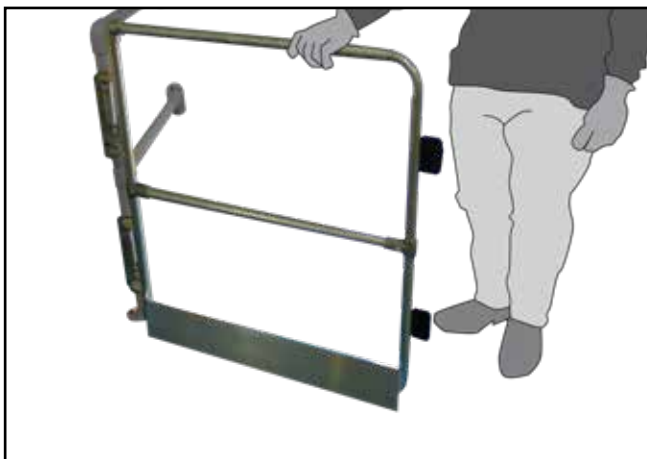

P. Manually open the gate at 45 degrees from its closed position.

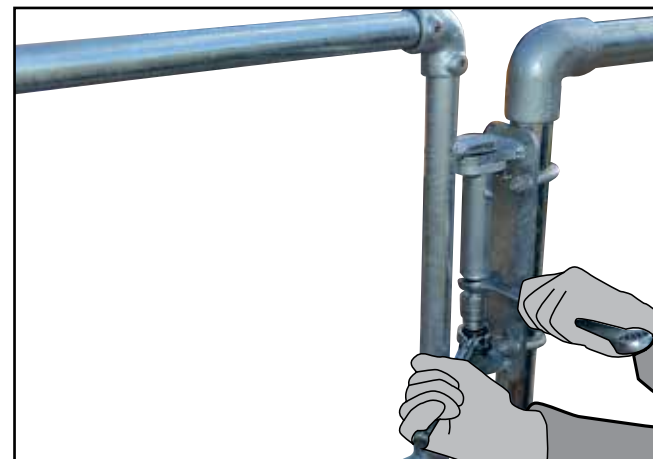

Q. Using the 24mm socket & ring spanner start to tighten the bolt until the gate completely closes. (Note:- You may have to hold the socket whilst using the ratchet).

Caution! Over tensioning of the spring assembly will result in failure of the product!! Do not tighten bolt more than one complete turn!



R. Once the gate is completely closed, tighten the locking nut to hold the tension. Caution:- Continue to hold the ratchet firmly and do not release until the lock nut is tightened. Now remove the socket and spanner from the hinge. Repeat as necessary to ensure that the gate closes sufficiently once opened and released. **DO NOT OVERTIGHTEN SPRING**





TOOLS REQUIRED

You will need the following in order to install the Kee Gate:

- Marker pen
- Tape measure
- 1No 15/16" Ring spanner
- 1No 1/2" Socket
- 1No 11/16" Socket
- 1No 15/16" Socket
- 1No 3/16" Hex key socket
- 1No 6mm Hex key socket
- Torque Wrench 10- 60 Nm approx
- Hacksaw or similar
- Small magnetic level

Mounting Gate to Upright

Establish that the gate will close in direction of hazard!!
Failure to do so could result in death or serious injury.



A. Align the fixing plate on internal face of the opening, so that the rails of the safety gate match up with the top of the guardrail system. Select the correct U-Bolt & pass around the support leg/structure and feed through the top holes of the fixing plate.

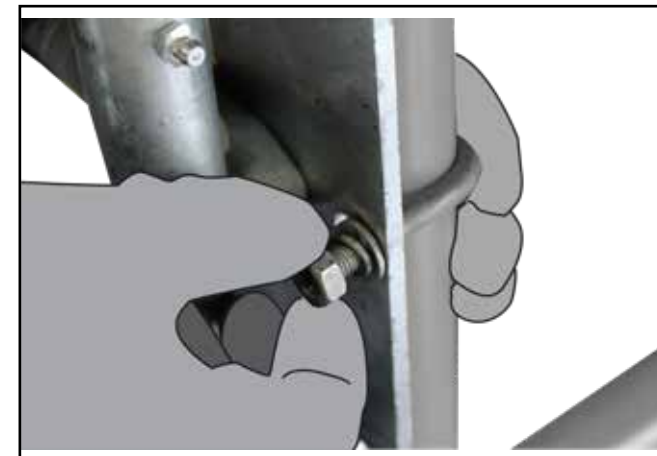

B. Using a M8 or M10 flat washer and nut connect the U-Bolt to the support leg/structure and tighten.



E. Torque all nuts/U-Bolts to 25Nm using the 13mm or 17mm socket and torque wrench.

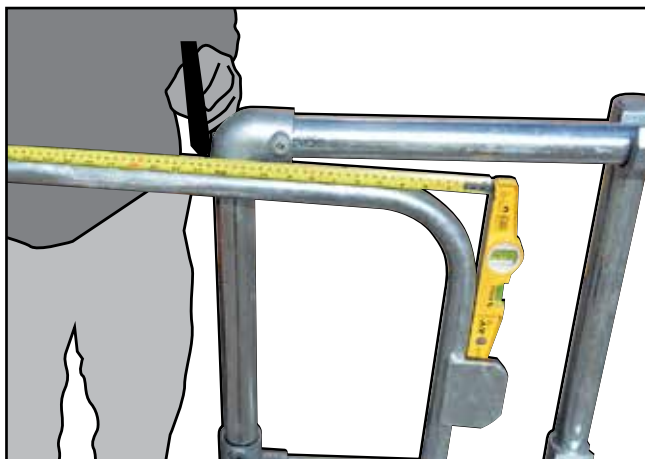

F. To cut the gate to the correct size simply place a straight edge/magnetic level as shown and measure the distance to the point where the outside edge of the vertical tube meets the supporting structure as shown. **(DO NOT CUT AT THIS MARK!)**

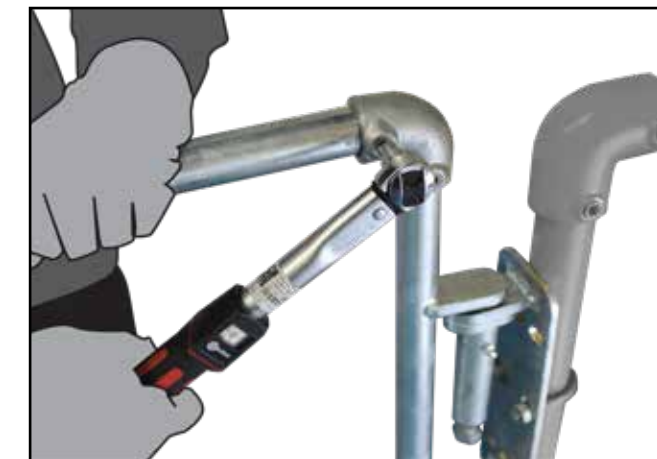

G. Disconnect the tubular gate from the hinge assembly by loosening the top & bottom cast clamp grub screw using a hex head socket as shown.

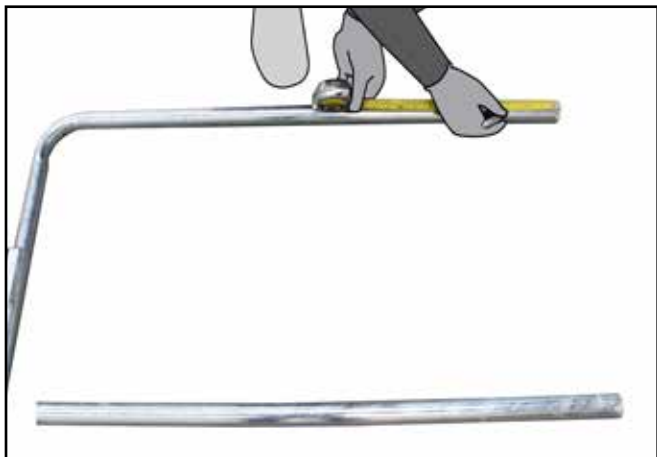

H. Measure the distance recorded in point (f) and mark the gate's top and bottom tubes and mid rail as shown.

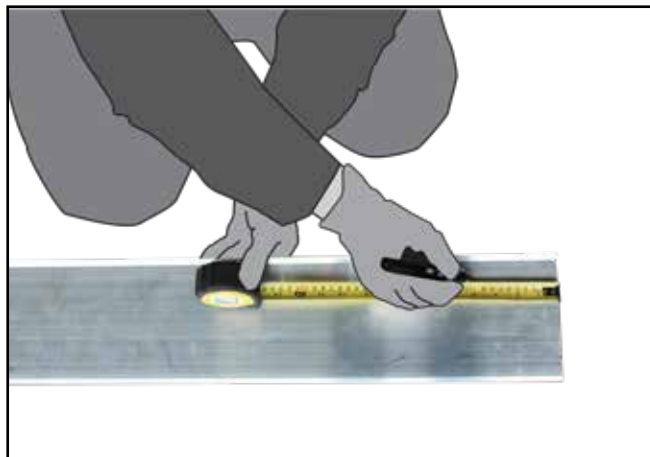

H. Measure the distance recorded in point (f) and mark the toe board as shown.

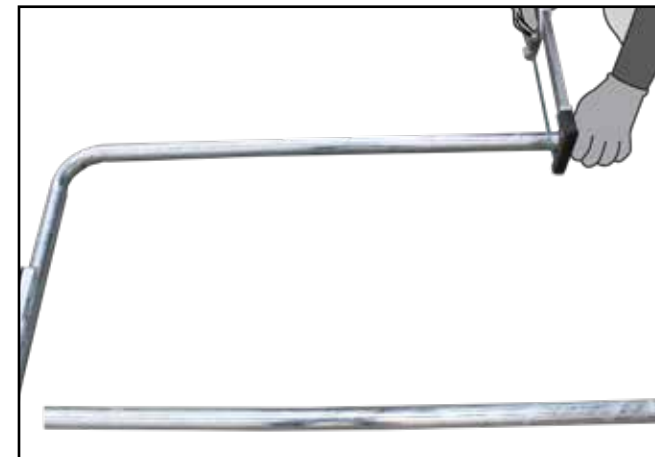

I. Using a hacksaw or similar, carefully cut through the top, bottom tubes, the toeboard and the mid rail as shown. For galvanised assemblies, spray with Galvafroid or similar to prevent corrosion.

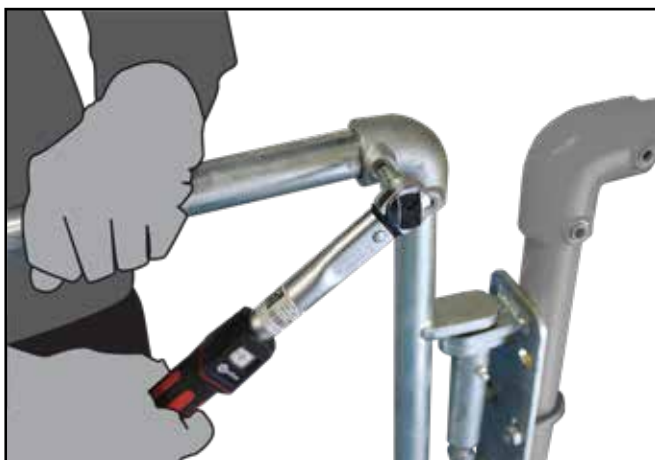

J. Carefully re-position the gate's top and bottom tubes into the cast fittings. Ensure the striking plate is on the correct side of the support leg/structure. Use a spirit level to ensure the gate is level. Tighten the cast fitting's grub screws using a hex head socket. Using the torque wrench ensure the castings are torqued to 39Nm.

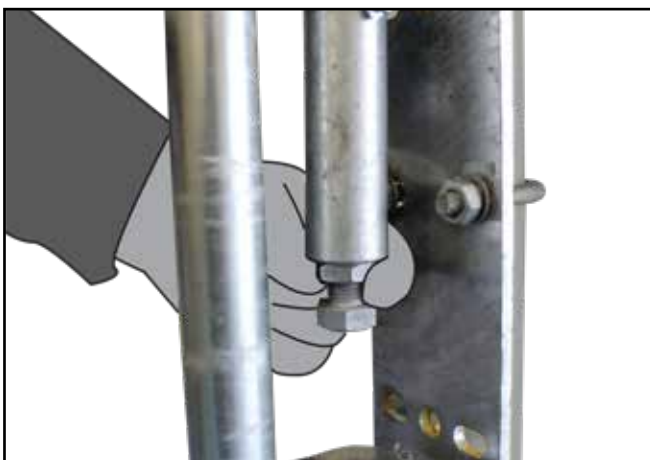

K. To tension the hinge loosen the locking nut as shown.

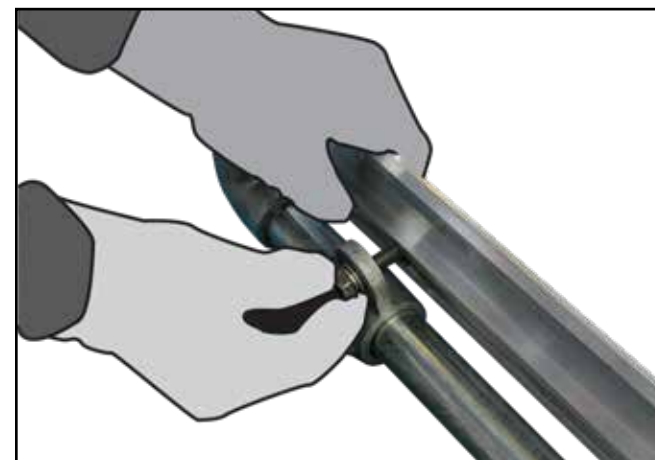

K. Use the supplied M8 nuts, bolts and spring washers to attach the toeboard to the gate.

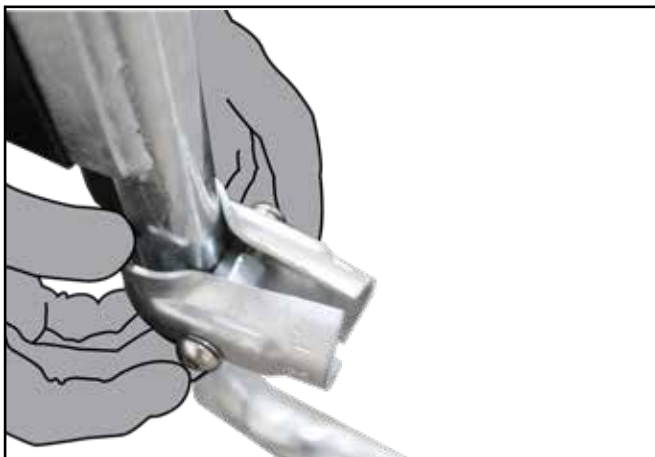

O. Mount clamp on lower part of gate, just above the bend and insert mid rail. Use 6mm hex head socket to tighten supplied M10 bolts into coupling nut.



P. Add clamp onto other end of mid rail, clamping onto the gate upright. Use 6mm hex head socket to tighten supplied M10 bolts into coupling nut.



Q. Use a measuring tape to ensure the gap between top rail and mid rail is no more than 470mm. Adjust if necessary.

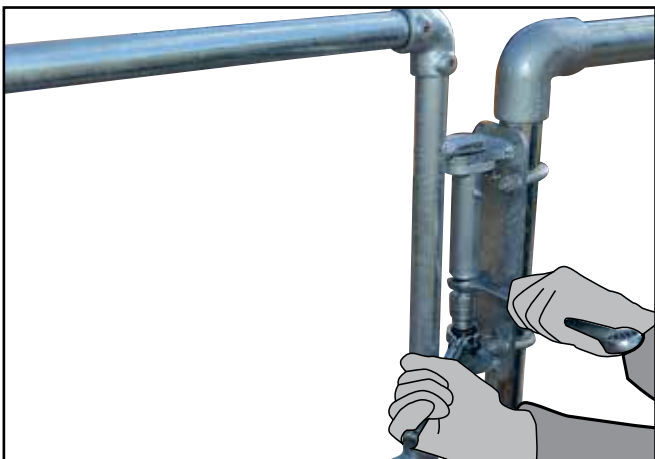

R. Loosen the locking nuts on the spring mechanisms as shown.

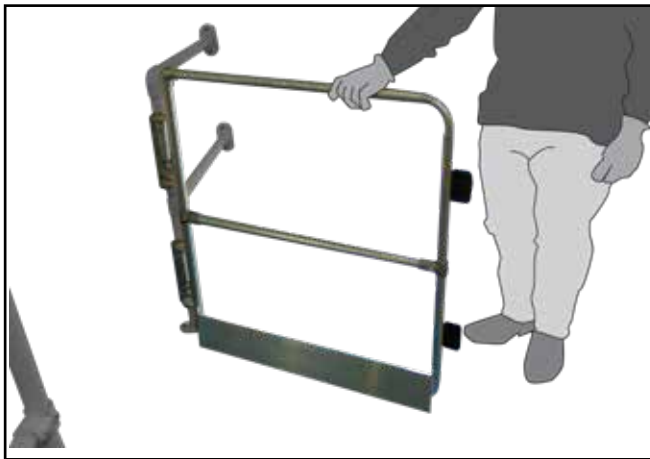

S. Manually open the gate at 45 degrees from its closed position.

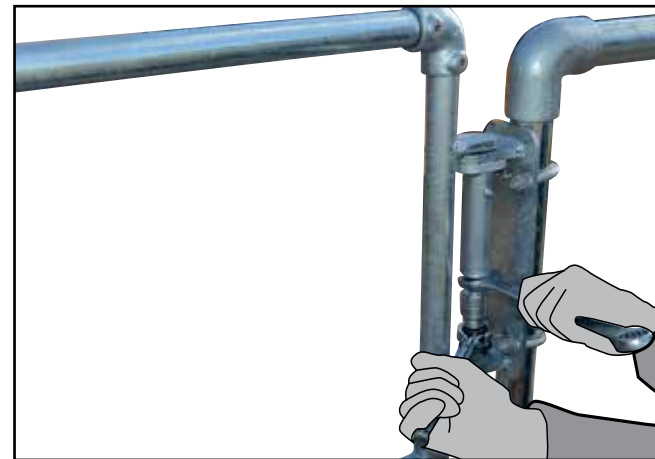

T. Using the 24mm socket & ring spanner start to tighten the bolt until the gate completely closes. (Note:- You may have to hold the socket whilst using the ratchet).



Caution! Over tensioning of the spring assembly will result in failure of the product!! Do not tighten bolt more than one complete turn!

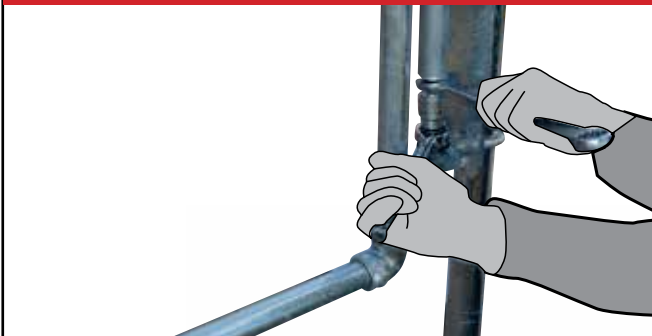

U. Once the gate is completely closed, tighten the locking nut to hold the tension. Caution:- Continue to hold the ratchet firmly and do not release until the lock nut is tightened. Now remove the socket and spanner from the hinge. Repeat as necessary to ensure that the gate closes sufficiently once opened and released. **DO NOT OVERTIGHTEN SPRING**

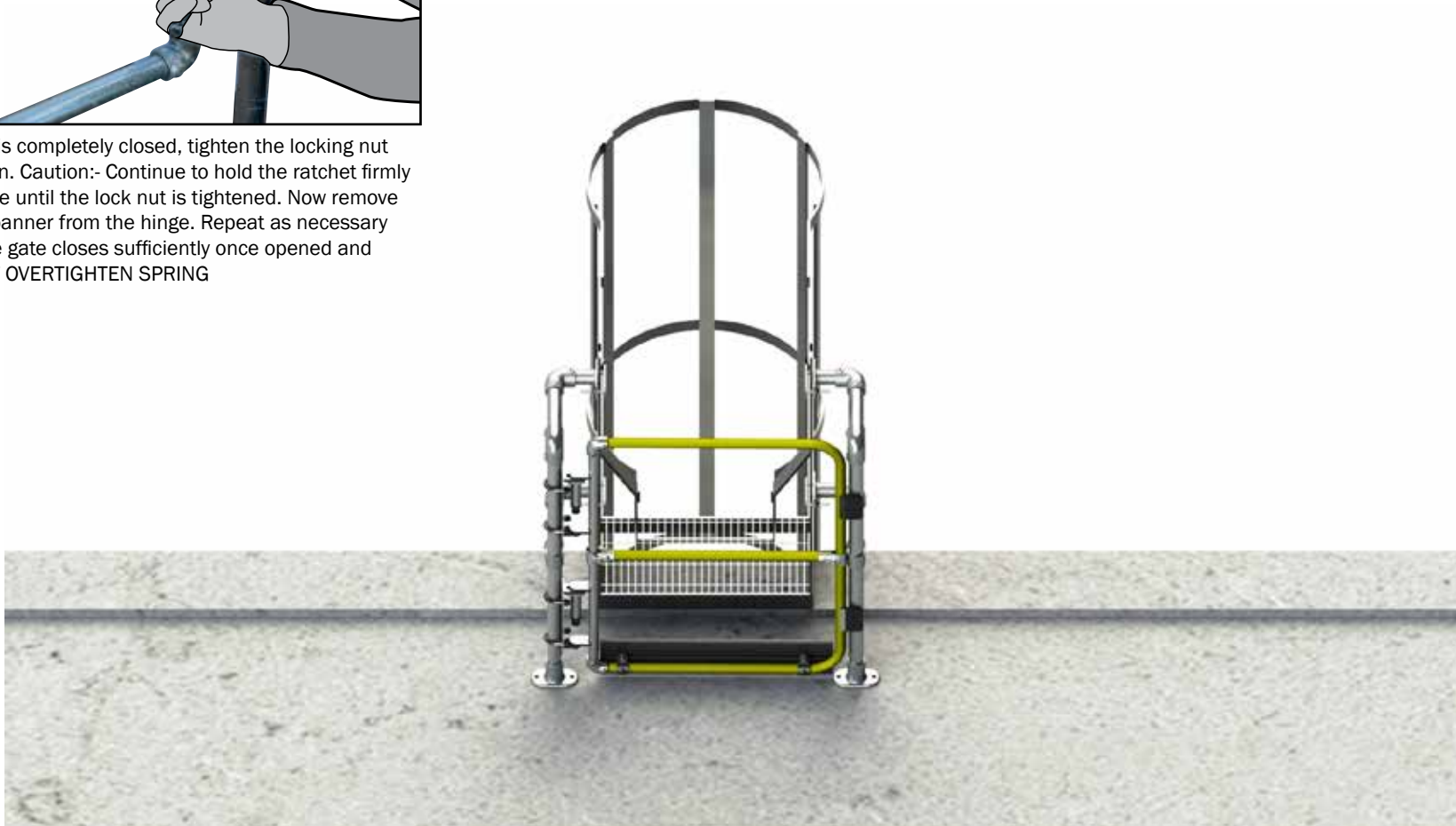

Periodic inspections by a competent person are recommended by the manufacturer. In UK/Europe these are required under Regulation 5 of the Workplace (Health, Safety & Welfare) Regulations, the Work at Height Regulations and Provision and Use of Work Equipment Regulations.

The frequency will depend upon the environment, location and usage but should be at least every 12 months.

- Visually inspect the complete installed product in relation to the client's needs. Establish if any modifications and/or additional products are required to reflect any refurbishment requirements or additional plant & equipment which have been installed and require access.
- Check installation configuration is complete as per the original installation drawing/plan.
- Ensure the product has not been modified or tampered with by unauthorised persons.
- Check the functionality of the product.
- Check the spring is correctly tensioned.
- Check all fixings are in place, greased and sufficiently torqued.
- Check the general height and level of the product.
- Any galvanised components showing signs of corrosion should be wire brushed thoroughly and galvanised spray/paint applied as appropriate. If rusted significantly, take digital photographs and include these in the inspection report.
- Inspect powder coated product surfaces and note any imperfections or general degradation.
- Check fixings to walls/structures including cat ladder clamps are in place, greased and sufficiently torqued.
- Check system plaque position & mark up to reflect date of the next required inspection. Establish if additional plaques are required due to any refurbishment works.



Scan this QR Code to find out more about Kee Safety products.



Kee Safety LLC
Dubai Investment Park (DIP)
Near Green Community
PO Box 18448
Dubai, UAE

Tel: (+971) 4 8859066
Fax: (+971) 4 8859065
Email: uaesales@keesafety.com
www.keesafety.ae