



SAFETY AT THE HIGHEST LEVEL

Kee Track® Instructions for Use Manual



CONTENTS

Page 3 1. Important Information

Page 6 2. Basic Safety Instructions

Page 7 3. Overview

Page 8 4. Layout and Specification

Page 10 5. Components

Page 12 6. Assembly and Installation

Page 39 7. Kee Track - Inspection

Page 40 8. General Information



1. IMPORTANT INFORMATION

1.1 Validity

These operating instructions apply to the following product:

Type: Kee Track®

Model Year: 2021

1.2 Authorised Agent

Kee Safety Limited

Cradley Business Park

Overend Road

Cradley Heath

B64 7DW

Tel: +44 (0) 1384 632188

E-Mail: sales@keesafety.com

Internet: www.keesafety.co.uk

1.3 Compatibility

Kee Track is designed to provide continuous protection against falls in almost any situation where there is a need to work at height, where collective protection measures are not available. When installed on suitable load bearing structures and used as part of a complete fall protection system according to these instructions, Kee Track is tested and demonstrates compliance to the requirements of:

- EN795:2012 Type D - Personal fall protection equipment. Anchor devices
- PD CEN/TS 16415:2013 - Personal fall protection equipment. Anchor devices. Recommendations for anchor devices for use by more than one person simultaneously
- BS8610:2017 - Personal fall protection equipment. Anchor systems
- OSHA 29 CFR 1926.502 (d)(15) Fall protection criteria and practices

Kee Track is suitable for use in complete fall protection systems designed and specified by the following standards:

- ANSI Z359.6-2016 - Specifications & Design Requirements for Active Fall Protection Systems
- CSA Z259.16-15 - Design of Active Fall-Protection Systems

The Kee Track system shall be used with PPE that includes a means of dissipating energy that limits the maximum impact force to 6 kN, and that is certified to one or more of the following:

- EN 360 - Self retractable type fall arresters (> prEN 360:2016)
- EN 355 Personal protective equipment against falls from a height – Energy absorbers
- ANSI Z359.14-2014 - Safety Requirements for Self-Retracting Devices for Personal Fall Arrest And Rescue Systems
- ANSI Z359.13-2013 Personal Energy Absorbers and Energy Absorbing Lanyards
- CSA Z259.2.2-17 - Self-Retracting Devices
- CSA Z259.11-17 Personal energy absorbers and lanyards

As there is the possibility of the system having to arrest a fall only full body harnesses certified to one or more of the following shall be used:

- EN 361 - Full body harnesses
- ANSI Z359.11-2014 - Safety Requirements for Full Body Harnesses
- CSA Z259.10-2018 - Full Body Harnesses

1.4 Health and Safety

Installers and users must comply with all relevant health and safety regulations in their given territory.

1.5 Familiarisation

All installers and inspectors shall be certified in the installation and inspection of Kee Track. All users shall be authorised, trained, competent and in possession of the manufacturer's documentation prior to use.

1.6 Certifying Body

Kee Safety Test & Development Centre, Cradley Heath, UK.

1.7 Anticipated Life

Metal Components: Up to 25 years in non-marine, non-corrosive (e.g. chemical plant) environments with a temperature range from -35°C to 65°C / -31°F to 150°F subject to use and a mandatory annual inspection strictly in accordance with these instructions.

1.8 Safeguarding the Instruction Manual

This Instructions for Use document forms a component part of the Kee Track system. This document must be followed for assembly. At no time must any pages be removed from these instructions. If the instructions are lost in their entirety or in part they must be replaced immediately.

1.9 Copyright

This documentation contains information protected by copyright. It may not be photo-copied, reproduced, translated or recorded on data media, either completely or as extracts, without prior written permission of Kee Safety. We reserve all further rights.

1.10 Amendment Service

This document is not subject to any amendment service from the manufacturer. Amendments to this documentation can be carried out without prior notice.

1. IMPORTANT INFORMATION

1.11 Modifications to The Kee Track system

Any modifications made to the Kee Track system will negate all certification or warranty that comes with this product.

1.12 Definition “Authorised Person”

A person assigned by their employer to perform duties that require the use of the Kee Track in accordance with these instructions.

1.13 Definition “Trained Person”

An authorised person having training, knowledge, and experience required to safely perform a work task that includes the use of the Kee Track system together with other protective measures.

1.14 Use in Accordance with Regulations

The Kee Track system is a Rigid Horizontal Anchor rail system. It is an integral part of a personal protection system for the prevention of falls from heights and may be used only in conjunction with the relevant personal protective equipment and in accordance with regulations in force in the location of use and these instructions. Where regulations conflict with these instructions use the most stringent requirement and contact Kee Safety for clarification.

1.15 Incorrect Use

The following conditions are examples of incorrect use:

- The use of the Kee Track system when one of the conditions listed under “use in accordance with regulations” is not met
- The failure to observe the minimum fall clearance
- The use of a damaged, incomplete or incorrectly assembled Kee Track system Including the use of a system that has not been inspected and found fit for use
- Use by a person who is not an authorized and trained person

Use of The Kee Track Rigid Horizontal Anchor Line in any of the above conditions is forbidden

1.16 Operator’s Duty of Care

The duties and obligations of the operator and trained personnel when dealing with the Kee Track system are set out below.

Safety of The Kee Track system

a) The operator or trained personnel must ensure that the Kee Track

- Is used only in accordance with Health and Safety regulations
- Is made available for use only in a proper, functional state
- Is used in accordance with these instructions
- Has a current and valid documented inspection in force at the time of use and will undergo a pre-use inspection prior to use
- Is used only by authorised and trained personnel

b) Protection of Personnel

All persons using the system must ensure that the necessary personal protective equipment

- Is available for use and IS USED (See 1.3 Compatibility)
- Is checked regularly and the check recorded

c) Instruction and Training

All users of the system must ensure that:

- Before using the system for the first time and at least once annually thereafter, all personnel shall be instructed in all relevant matters of health and safety at work (with particular emphasis on Working at Height) and environmental protection

- The operating instructions are always available in a legible state, are complete, and are kept with the system. Always ensure users are familiar with the contents of these operating instructions

1.17 Medical Condition of Users

Users of Kee Track as part of a fall protection system should be physically capable and free from any impairment that could prevent them from working safely.

1.18 Personnel Requirements

DANGER TO LIFE! 

Users of Kee Track should be trained and competent in its safe use and in the use of all attached components. If any of the information or marking is not fully understood, or if it is considered that more information is required to work safely, users are strongly recommended to contact the supplier or manufacturer before using this equipment in the workplace. The requirements the manufacturer places on the users of the Kee Track system are as follows:

a) Duties of the User

The user must fulfil the following duties:

- Assemble the Kee Track system strictly in accordance with this Instructions for Use Manual and check that the system is functioning correctly and safely
- Recognise any defects and withdraw the system from use and alert the manufacturer so an assessment and required repairs can be completed

b) Requirements of the User

In order to be able to fulfil his or her duties, the user must meet the following requirements:

- The user must be competent in the selection and use of the PPE combination used in conjunction with the Kee Track system
- They must have adequate knowledge of the relevant language to understand these operating instructions
- They must be free from any disability that may affect their ability to use this system or understand these instructions

It is unlikely that any medical condition may directly affect (or be affected by) the use of this product in itself, but users must be aware that:

- Working at height is a dangerous occupation. They should be trained to do so and should comply with any medical requirements set by the training provider
- The manufacturer or supplier of PPE to be used with this product may impose medical requirements on users of their products, which must be complied with

1.19 Rescue

DANGER TO LIFE! 

Before working at a height commences and at regular intervals thereafter for the duration of the job, a task assessment should be made and a risk assessment produced. This assessment should include all possible emergency scenarios and a plan should be in place as to how any resulting rescues would be carried out quickly and efficiently. Remember that the survival of an injured person often depends on the speed of rescue and the care given to the casualty during and after the rescue.



2. BASIC SAFETY INSTRUCTIONS

DANGER TO LIFE!



It is imperative that you follow these safety instructions to avoid endangering your life and safety.

Possible Danger

DANGER TO LIFE!

Risk of fatalities / injuries as a result of incorrect system assembly.

Explanation: Falls resulting in death or severe injuries can result from the defective assembly of the Kee Track system.

DANGER TO LIFE!

Risk of fatalities / injuries as the result of poor layout design /positioning.

Explanation: Falls resulting in death or severe injuries can result from installing the Kee Track system in areas which increase the risk of falling, or falling in an area with insufficient free fall distance to arrest a fall.

DANGER TO LIFE!

Risk of fatalities / injuries as the result of installing the Kee Track system into / onto weak structure.

DANGER TO LIFE!

Risk of fatalities / injuries as a result of defective or inadequate maintenance.

Explanation: Defects or damage relevant to safety can adversely affect the functionality of the Kee Track system. In these circumstances, the safe functioning of the system is not assured.

Measures of Avoidance

Assemble the Kee Track system only as described in this Instructions For Use Manual. After assembly and before use, check all components and connector parts for correct assembly & positioning. Damaged parts shall not be used for assembly.

Ensure that there is adequate fall clearance should a user fall. For example, all structures and objects below working position. Ensure fall clearance is adequate by consulting the Kee Track Calculator.

Ensure the structure to which the Kee Track system is to be installed into / onto has sufficient strength and load-bearing capacity to ensure the structure does not fail during normal use, or when the system arrests a fall. When in doubt, guidance from an experienced structural engineer and/or Kee Safety should be sought.

Before use, check Kee Track for damage. Damaged components must be replaced before use in all cases. Only after authorised repair may the Kee Track system be used!

3. OVERVIEW

The Kee Track® Fall Protection System (Kee Track®) is a rigid rail overhead track system. It offers the safety of short fall arrest distances with the ease, economy and flexibility of modular installation.

It is particularly effective when users work at short free fall distances, such as carrying out operations on trains, trucks and aircraft with low ground clearances. Additionally, the lightweight trolley with sealed bearings allows complete hands-free movement throughout the system.

One of the main advantages of Kee Track is the unique range of mounting options. The system can be made secure to internal roof structures such as beams, trusses, and concrete. Where necessary, bespoke connectors can be supplied.

For primary and secondary steelwork: Kee Track works with the columns, rafters and bracing of primary steelwork, and the purlins of secondary steelwork.

Parallel or perpendicular: Up and down or side to side? Or both? Whichever way you organise your facility, the flexible mounting options ensure Kee Track is optimised to work the way you do.

No limits: Whatever the length and breadth of your roof, Kee Track can cover it. The only restriction is that the system is configured in straight lines.



4. LAYOUT AND SPECIFICATION

This layout and specification assistance is designed for those attaching to secondary steel roof purlins. Other attachment options are available. Contact Kee Safety directly to learn about these alternative attachment methods.

Kee Track can be attached to roof purlins in two primary configurations: Perpendicular and Parallel. The measurement process for each is similar, and the data collected on-site should be entered into a Kee Track Assessment Sheet. These assessment sheets are available from Kee Safety and can be downloaded here:

<https://keesafety.group/kee-track-survey>

The best way to learn how to measure and specify a Kee Track system is to watch the training video:

<http://keesafety.group/kee-track-video-imperial>

<http://keesafety.group/kee-track-video-metric>

Typical Surveyor Tools

The following tools are helpful when performing a Kee Track site survey:

- Kee Track Assessment Sheet
<https://keesafety.group/kee-track-survey>
- Tape
- Laser measure
- Tape measure
- Camera
- Marker pen

Installation Location

When considering where to install the Kee Track system, please think about the following:

- Kee Track comes in 3m sections
- Kee Track can support up to four users
- The track height should be 0.5m below the lowest support structure and as high as possible above the working surface
- Look out for possible obstructions, including dynamic ones such as rolling doors
- The track height should be at least 150mm higher than any rolling doors
- The working surface must be at least 2.5m below the track
- The users should be working no more than 30 degrees from centre when connected to the Kee Track system

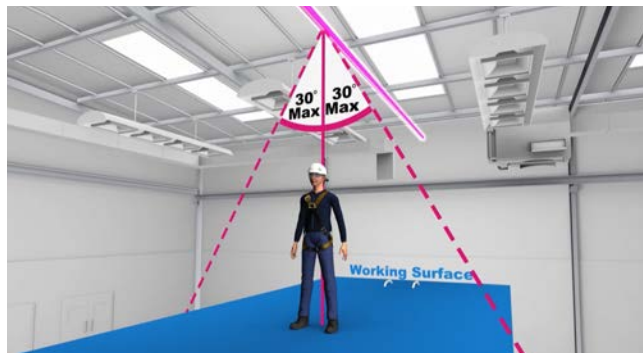

- If any of these conditions cannot be met, please contact Kee Safety for additional guidance

After you have established the track height and the location of the track in the facility, you can move on to measuring the purlins.

NOTE: It is highly recommended that you use photography to document the surrounding area (both floor and ceiling) where the Kee Track system is going to be installed.

Perpendicular Purlin Measurement

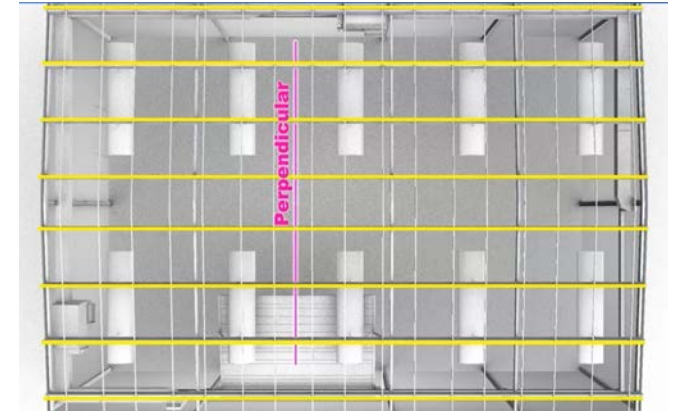

If a building drawing exists, this information can be extracted from there, otherwise a site survey will need to be performed. The following pieces of information will need to be collected to properly layout a perpendicular Kee Track system. Record all of this in the Kee Track Assessment Sheet.

1. You need to record the shape, depth, thickness, and length of the purlins
2. Starting at the first purlin, you need to record the height of each purlin to which the system will be attached. A simple way to achieve these measurements is to align yourself under the purlins and measure the height of the purlin using a laser measure. Mark each measurement location on the ground with tape. [NOTE: you need to ensure that the floor is level for this method to work properly]
3. Starting at the first tape mark, measure the distance between each purlin with a tape measure. Record these distances in the Kee Track Assessment Sheet

Parallel Purlin Measurement

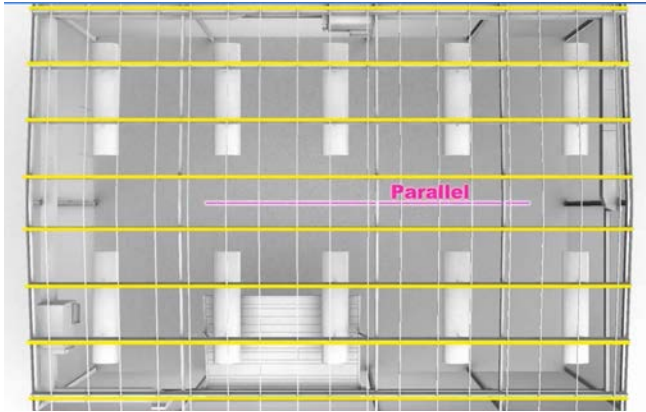

If a building drawing exists, this information can be extracted from there, otherwise a site survey will need to be performed. The following pieces of information will need to be collected to properly layout a parallel Kee Track system. Record all of this in the Kee Track Assessment Sheet.

1. The overall length of the system
2. The maximum number of users
3. The height of the track
4. The height of the purlins that the track will be connected to; one on each side - A simple way to achieve these measurements is to align yourself under the purlin and measure the height of the purlin using a laser measure. Mark each measurement location on the ground with tape. [NOTE: you need to ensure that the floor is level for this method to work properly]
5. The distance between the two purlins. Measure the distance between the tape marks with a tape measure

6. The distance between the first purlin and the track. Place a tape mark in the expected location of the track between the two purlins. Measure the distance between the tape marks with a tape measure.

Developing a Bill of Materials

Once all of the required information has been collected, it can be entered into the Kee Track Assessment Sheet (Excel Version). This will then output the required bill of materials to construct the system that you have specified.

All of the required lengths and geometry, as well as a system safety check, will be the output along with the bill of materials.

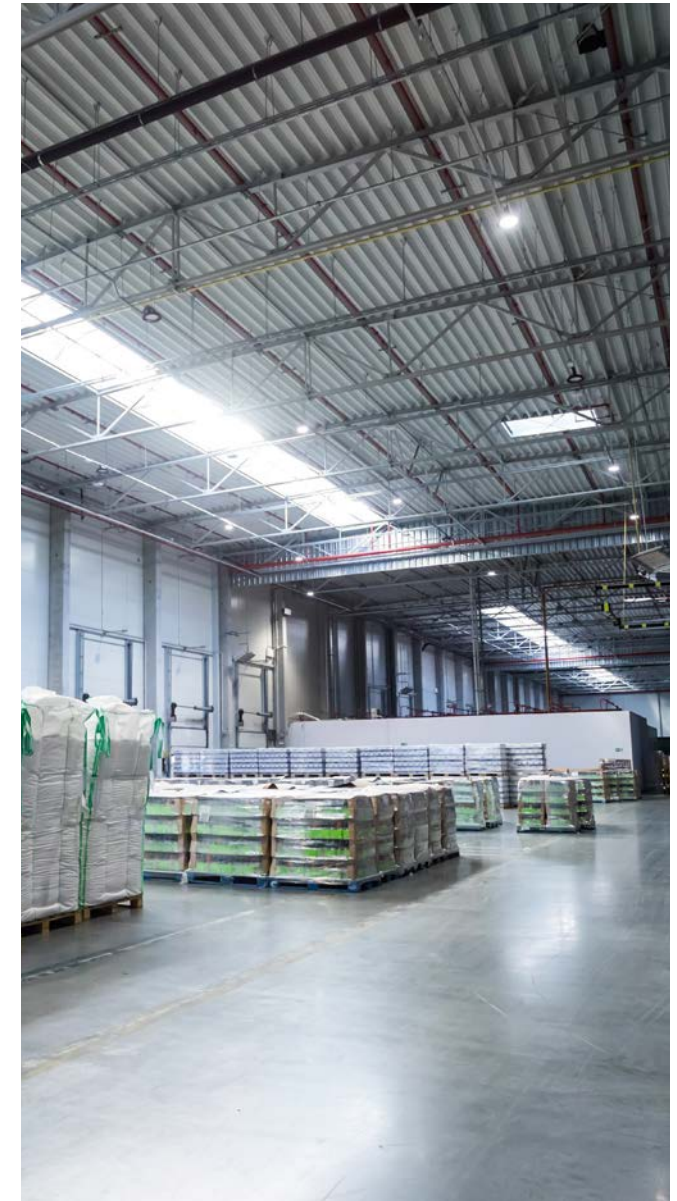

5. COMPONENTS

For further information go to: <http://keesafety.group/kee-track-data-sheets>

600 SERIES RIGID RAIL 3M / 9'10" SECTION - GALV
Part No: 10FR600



A

HANGAR LINK ARM BRACE - 1M / 3'3"
Part No: TLA1000

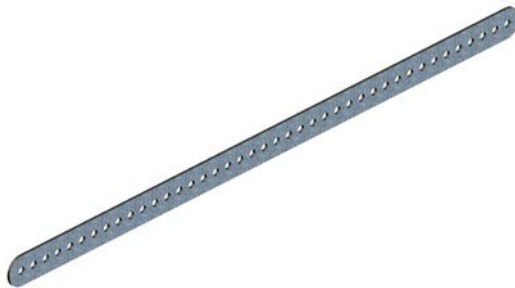

D

HANGAR LINK ARM - 1M / 3'3"
Part No: LA1000



G

PURLIN BRACKET - PARALLEL
Part No: TAB001



B

HANGAR LINK ARM BRACE - 0.5M / 19-5/8"
Part No: TLA500



E

HANGAR LINK ARM - 0.5M / 19-5/8"
Part No: LA500



H

PURLIN BRACKET - PERPENDICULAR
Part No: TFB001



C

HANGAR LINK ARM - 2M / 6'6"
Part No: LA2000



F

600 SERIES RAIL SPLICE - GALV
Part No: 10SP600



I

SLOTTED CLAMSHELL TOP BRACKET

Part No: AB600HS



J

KEE TRACK END STOP BUFFER

Part No: KTEND



M

KEE TRACK SYSTEM TAG

Part No: KT600STG

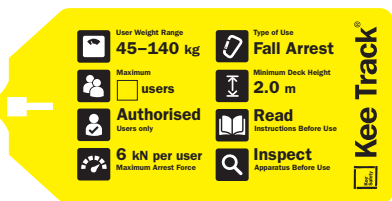

P

600 SERIES HALF CLAMSHELL - GALV

Part No: 10SP600H



K

7.7 BULB-TIGHT RIVET - BAG 100

Part No: KL2RIVET

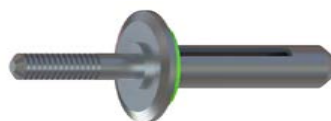

N

600 SERIES TROLLEY

Part No: 10TR600



L

KEE TRACK BRANDING LABEL

Part No: KT6LBL



O

6. ASSEMBLY AND INSTALLATION

Tools list

- **Tape measure**
- **Magnetic spirit level**
- **½” drive ratchet**
- **½” drive 150mm socket extension (where applicable)**
- **½” drive wobble socket/knuckle (where applicable)**
- **½” drive 17mm socket (M10)**
- **½” drive 19mm socket (M12)**
- **½” drive 24mm socket (M16)**
- **2 x 17mm ring or combination spanner**
- **2 x 19mm ring or combination spanner**
- **2 x 24mm ring or combination spanners**
- **Marker Pen**
- **Hammer & Centre punch**
- **Drill bits – 8mm HSS**
- **Calibrated torque wrench – ½” drive ratchet head attachment**
- **Riveter (Gesipa Powerbird or equivalent) capable of accepting 7.7mm (Kee Safety) aluminium bulb rivet**

Please note - operatives should only use the tools or materials for which they have received authorisation and training.

Torque table

Fixing bolt Diameter	Torque Setting Nm*	Torque Setting ft-lb*
M10	40	30
M12	60	45
M16	80	60

*Where torque wrench isn't available, tighten nut to point of flattening spring washer, then add a further quarter turn.

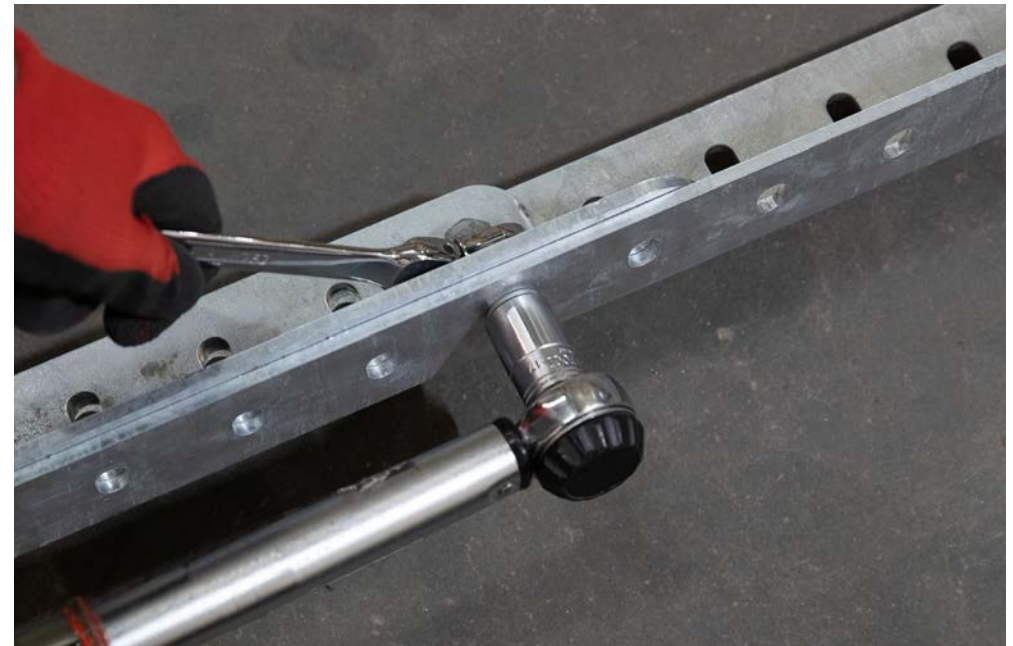

PERPENDICULAR RAIL INSTALL - Go to section 6.1 on page 14

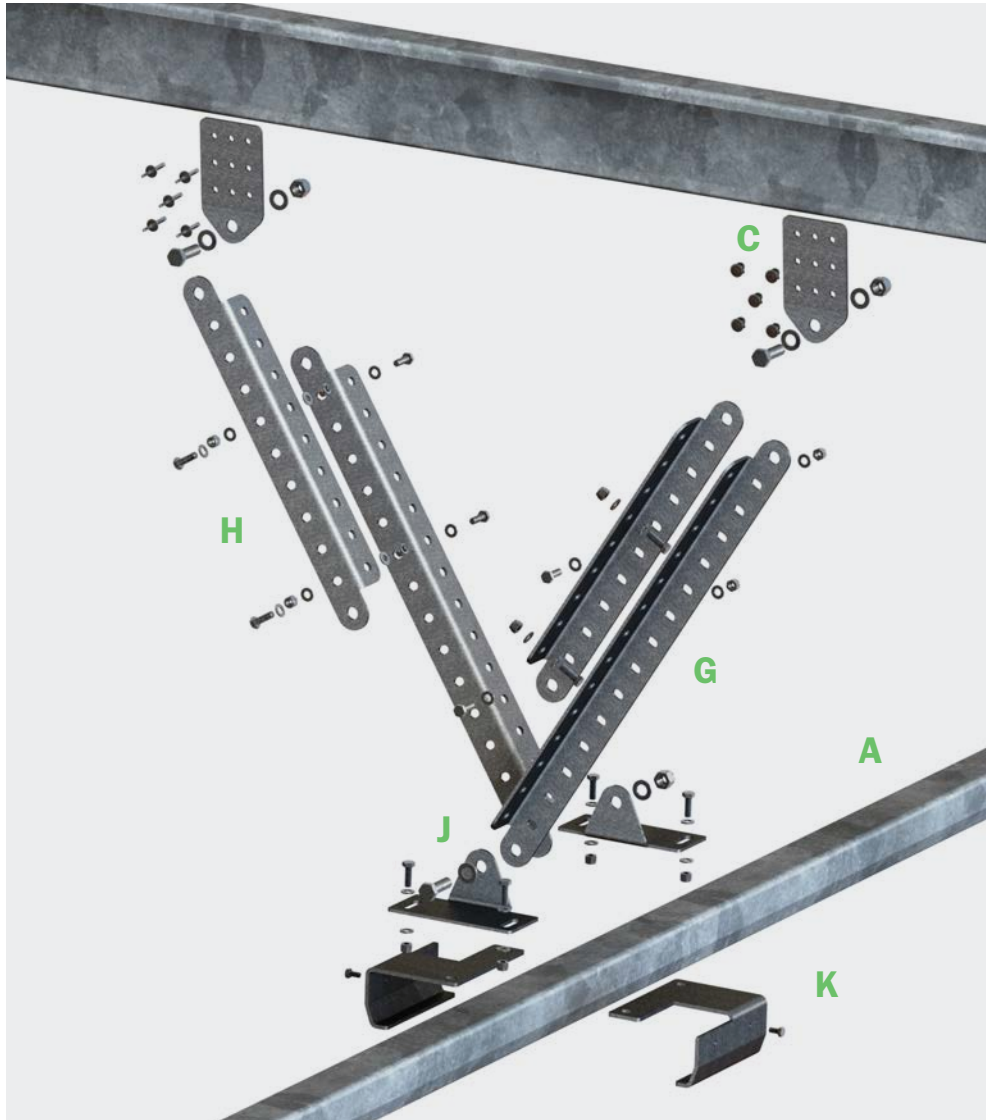

A-K Please refer to page 8-9 for component details.

PARALLEL RAIL INSTALL - Go to section 6.2 on page 20

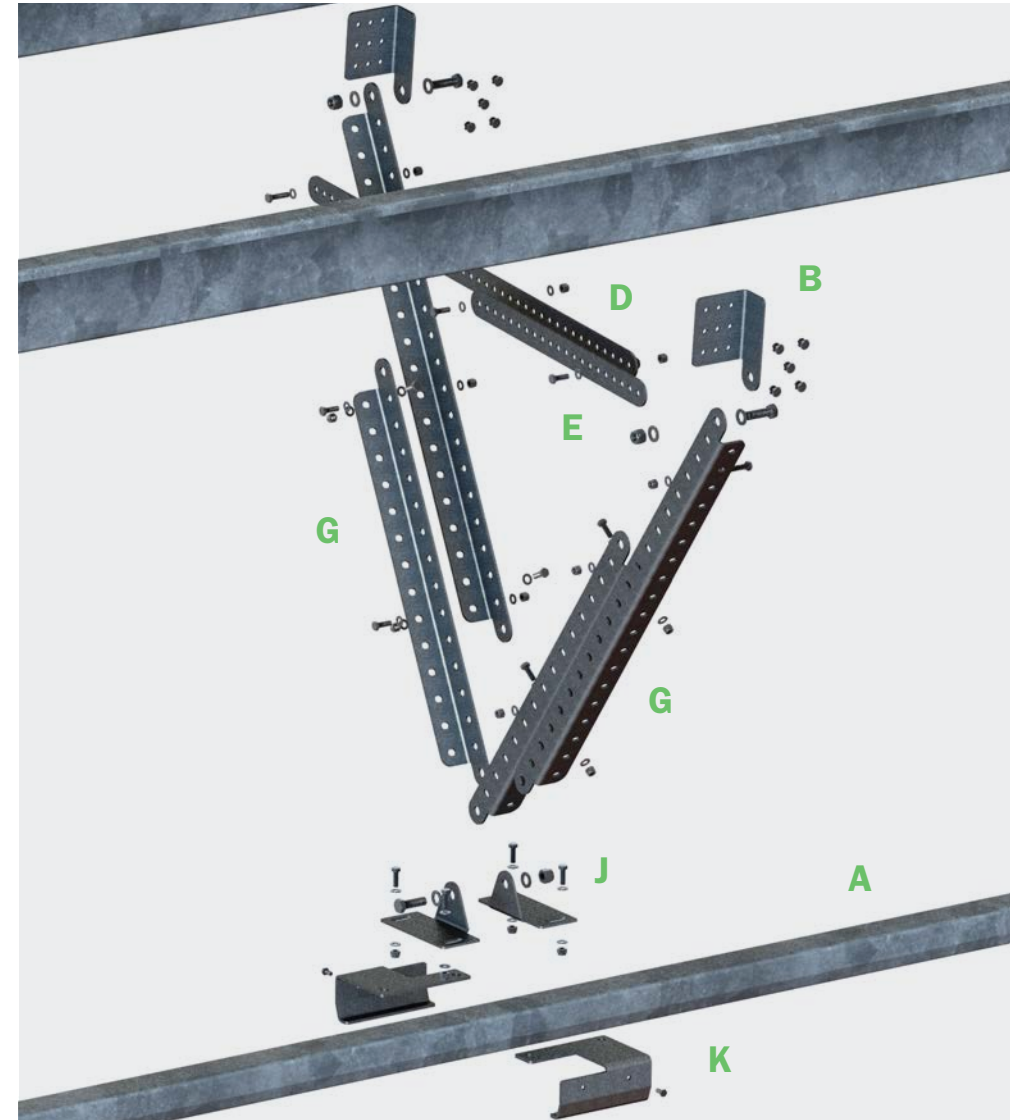

6.1 PERPENDICULAR Bracket Install

Note: For Parallel install go to section 6.2 on page 20

Step 1

From a known datum point, i.e. a wall, feature of the building etc. establish the centre line for the track, and mark purlin(s) to this effect.



6.1 PERPENDICULAR Bracket Install

Step 4

Offer up the TFB001 bracket on the previously marked centreline using the middle row of holes as datum. Ensure the bracket is orientated correctly (as shown in **Fig. 2**). The tab should point vertically downward. Mark through the upper right corner in preparation for drilling.



Fig. 1: Incorrect - bracket bends towards you

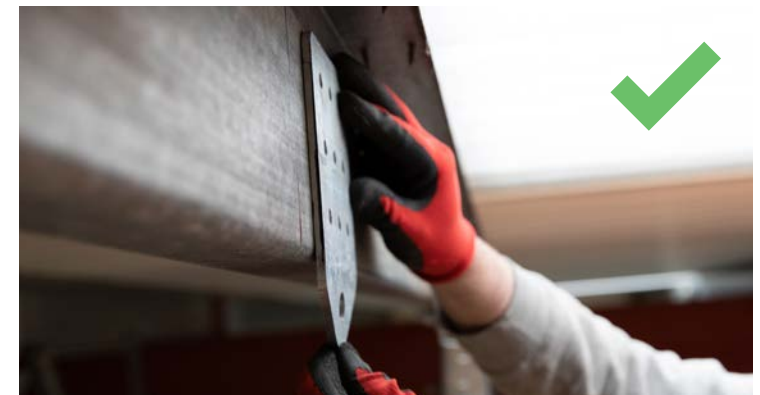

Fig. 2: Correct - bracket bends away from you

Step 5

Using a centre-punch, punch the position of the hole marked previously, and using an 8mm drill bit in a power drill, drill through the purlin at the point marked in preparation for rivet insertion.



Step 6

Align top right bracket hole with hole previously drilled through the purlin, insert rivet and deploy.



6.1 PERPENDICULAR Bracket Install

Step 7

Using a spirit level, ensure purlin bracket is upright, then using the holes as a guide (ensuring not to move the bracket) drill through the lower left rivet hole, then insert and deploy the rivet.



Step 8

Repeat steps 1-7 for the bracket on the opposite side of the centreline, finalise install by inserting five rivets into each bracket in the shape of an 'X' as shown.

Repeat steps 1-8 for the remainder of brackets on the system, as per installed position and offset as detailed in the project pack table. Note: one or more of the additional holes may be used in case one of the others intended for rivets cannot be used. A minimum of five rivets must be used for each bracket.

Note: Continue to section 6.3 on page 25



6.2 PARALLEL Bracket Install

Step 1

From a known datum point, i.e. a wall, feature of the building etc. establish the position for the first hanging bracket assembly. Mark purlin(s) with a vertical line at this point.

This will be the datum point by which all measurements are taken from.

Note: For Perpendicular install go to section 6.1 on page 14



Step 2

Align the TAB001 bracket along the folded return edge using the vertical line marked in Step 1.

Ensure that the lower edge of the bracket is at the bottom or underside of the purlin.

Using the rivet hole as a guide, mark the upper left hand corner.



Step 3

Using a centre-punch, punch the position of the hole marked previously, and using an 8mm drill bit in a power drill, drill through the purlin at the point marked in preparation for rivet insertion.



Step 4

Offer bracket up on marked line, align top left bracket hole with hole previously drilled through the purlin, insert rivet and deploy.



6.2 PARALLEL Bracket Install

Step 5

Using a spirit level, ensure purlin bracket is upright, then using the holes as a guide (ensuring not to move the bracket) drill through the lower right rivet hole, then insert and deploy the rivet.



Step 6

Using datum established in Step 1, in conjunction with rail trajectory, establish position for opposing purlin bracket.

Repeat steps 1-5 for this bracket.



Step 7

Once bracket is fixed in position, complete bracket install by drilling and deploying a minimum of five rivets in an 'X'.

Note: one or more of the additional holes may be used in case one of the others intended for rivets cannot be used. A minimum of five rivets must be used for each bracket.



6.2 PARALLEL Bracket Install

Step 8





Repeat Steps 5.2.1 – 5.2.7 for the remainder of the brackets on the system.

1st rail section brackets MUST be at 2.4m / 7'10" centres to allow fitting of the first section of rail.

Subsequent brackets fitted at centres as prescribed in the Kee Track System Assessment sheet.

Warning - do not exceed specified centres.



No. of Users	Span metres	Span ft-lb
	3.6	10'11"
	2.8	9'2"
	2.4	7'10"
	2.0	6'7"

6.3 Hanging Bracket Build-up

Step 1 Perpendicular

Using table shown in pack, identify the location in the system for the brackets being built (A), the link arms required (B) and their assembled centre to centre length (C). In the example shown below, for bay D, the installer will need 1 x LA1000 + 1 LA500 built to a centre to centre dimension shown inside the green box in column C.

Support Purlin	Measured Spacing	Support Height	Link Arm	Arm Length	Offset	Arm Angle
At end point, A	0.00	0.55 m	1-LA500	0.50 m	0.324 m	40 deg
Distance AB	1.15 m	0.65 m	2-LA500	0.60 m	0.355 m	36 deg
Distance BC	1.43 m	0.79 m	2-LA500	0.75 m	0.419 m	34 deg
Distance CD	1.40 m	0.93 m	1-LA1000	1.00 m	0.650 m	41 deg
Distance DE	1.57 m	1.07 m	1-LA1000 + 1-LA500	1.05 m	0.536 m	31 deg
Distance EF	1.70 m	1.19 m	1-LA1000 + 1-LA500	1.20 m	0.632 m	32 deg
Distance FG	1.65 m	1.33 m	2-LA1000	1.35 m	0.691 m	31 deg
Distance GH						
Distance HJ						
Distance JK						

Parallel

Using the table in pack, identify the type of arms required (E) and their assembled centre to centre length (D). In the example shown below, the left-hand hangar (XZ) uses 2 x LA2000's built to a centre to centre dimension shown inside the green box in column D.

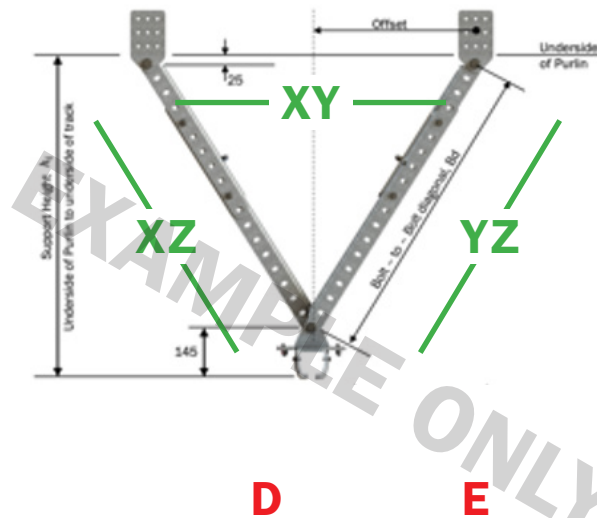

Results	Install Values	Link Arms	Theoretical Values	Installed Arm Angle to vertical
Arm length AC:	3.600 m	2-LA2000	3.615 m	38 deg
Arm length BC:	4.100 m	2-LA2000+1-LA1000	4.102 m	33 deg
Bridging AB:	4.300 m	2-LA2000+1-LA1000	4.313 m	

6.3 Hanging Bracket Build-up

Step 2

Using the project pack table dimensions, nest the required arms inside of each other ensuring that the M16 holes are parallel and in the same plane. Set the distance between M16 holes as prescribed by the table.



Step 3

Once in position insert the M10x40mm fixings through the arm assembly with the bolt head inward. Order of fixing is as shown below. Minimum of 4 bolts per connection, as far apart as is practicable and always with 2 x fixings in each flange in each face of the arm (see image below).



Step 4

Once arms are bolted together, confirm length is as detailed in project pack table. Tighten all bolts to torque shown in Torque Setting table on page 12. Repeat steps 1-4 for remaining hanging brackets for each position.

6.4 Hanging Brackets and Rail Assembly

Step 1

Hang arms onto purlin brackets – ensuring they are the correct length for the bay (if perpendicular). Use the Kee Track System Assessment sheet to verify the correct arm length for the section you are installing. Insert M16x50mm bolt and fixing pack as shown.



Step 2

Bring hanging brackets together to form a 'V'. Fit AB600H bracket, insert M16 x 50mm bolt.



6.4 Hanging Brackets and Rail Assembly

Step 3

Fit 2nd half of AB600H bracket to rear of hanging assembly, ensuring that assembly forms a sandwich either side of the hanger arms. Hand tighten at this stage.

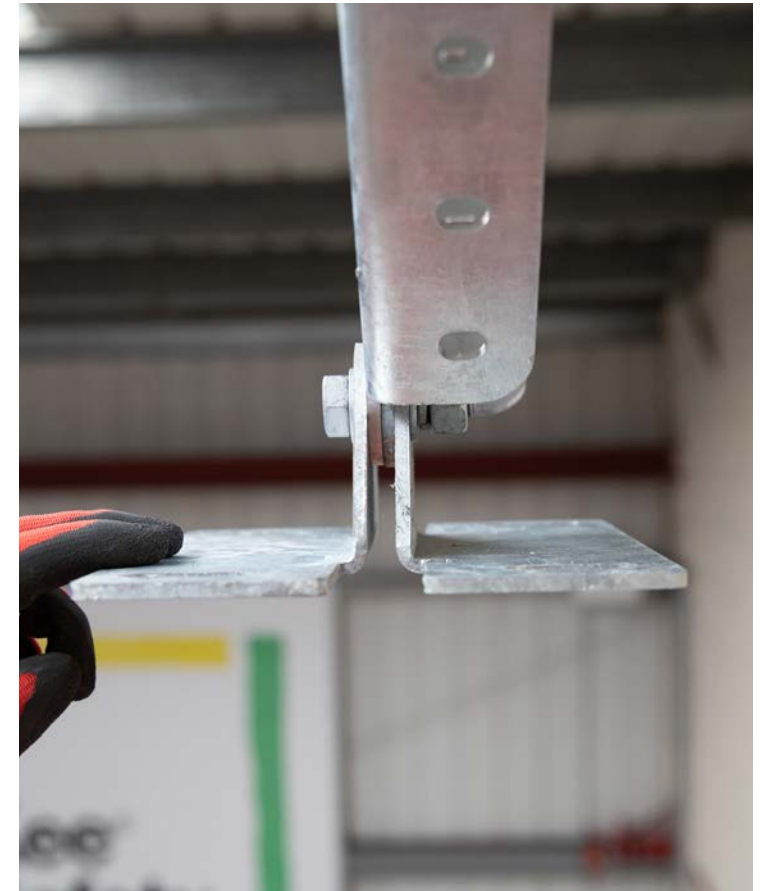

Step 4

Orientate the 10SP600H bracket parallel with the direction of the rail position, with the opening of the bracket facing towards you.

Use a spirit level to ensure hanger is level. Tighten all bolts to torque as shown in the Torque Setting table on page 12.



6.5 Rail Insertion and Securing

Step 1

Install rail onto two hanging brackets as shown in the picture below, ensuring end stop hole in rail is in the correct position as shown. Where the rail is terminated, ensure that the stop hole is positioned at the end of the track.

Ensure that remaining brackets are fitted to the rail and are ready to be slid into position.

Note: This is a two person operation, and each operative must be underneath, or in close proximity of, a hanger assembly.

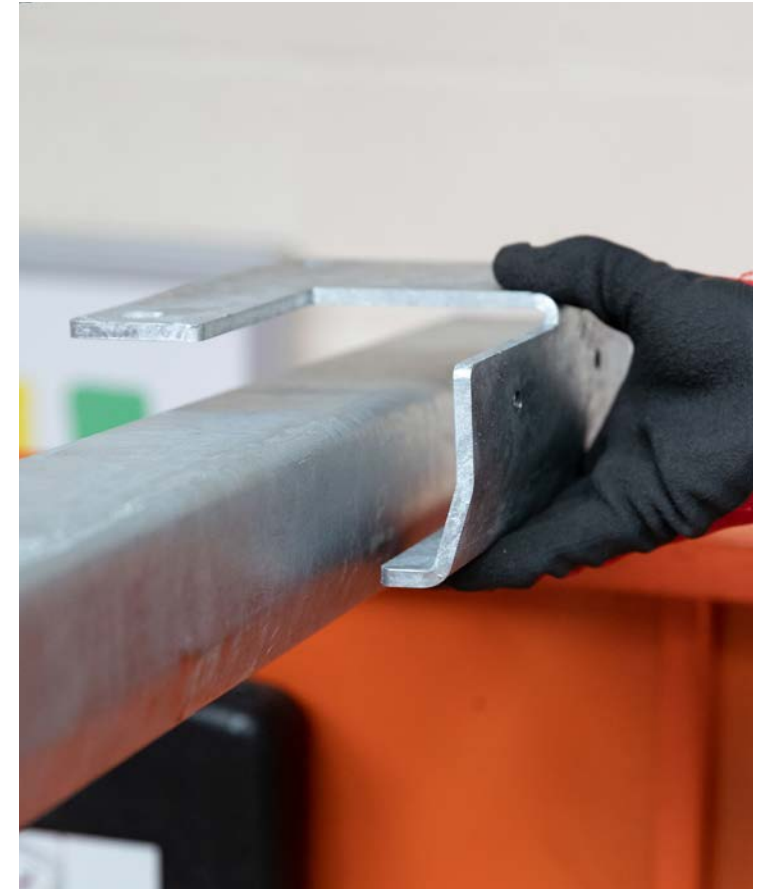

Step 2

As rail is inserted into hanger, slide the 10SP600H bracket towards the hanger assembly.

Insert remaining M12x40mm fixings into assembly, hand tighten.

Repeat procedure for any other hanging assemblies.



6.5 Rail Insertion and Securing

Step 3

Tighten all bolts on assembly to torque specified in the Torque Setting table on page 12.

Where this is the start of the rail, fit the end stop buffer and bolt through hole present in rail.



Step 4

Insert M10x20mm bolts into the side of the hanger assembly.
Tighten evenly so that all fixings are deployed equally keeping the rail central within the assembly.

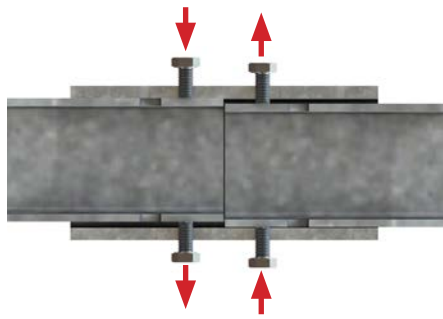

Incorrect alignment - Top view

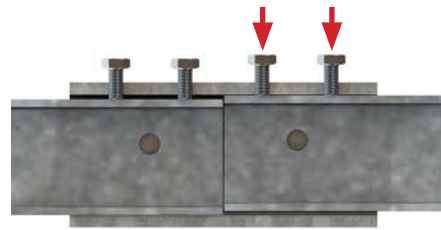

Incorrect alignment - Side view



Correct alignment - Top view



Correct alignment - Side view

6.6 Rail Joining and Bracing

Step 1

Where rail is to be joined with a splice, ensure that a minimum of 100mm / 4" of rail extends past the end of the hanger assembly.

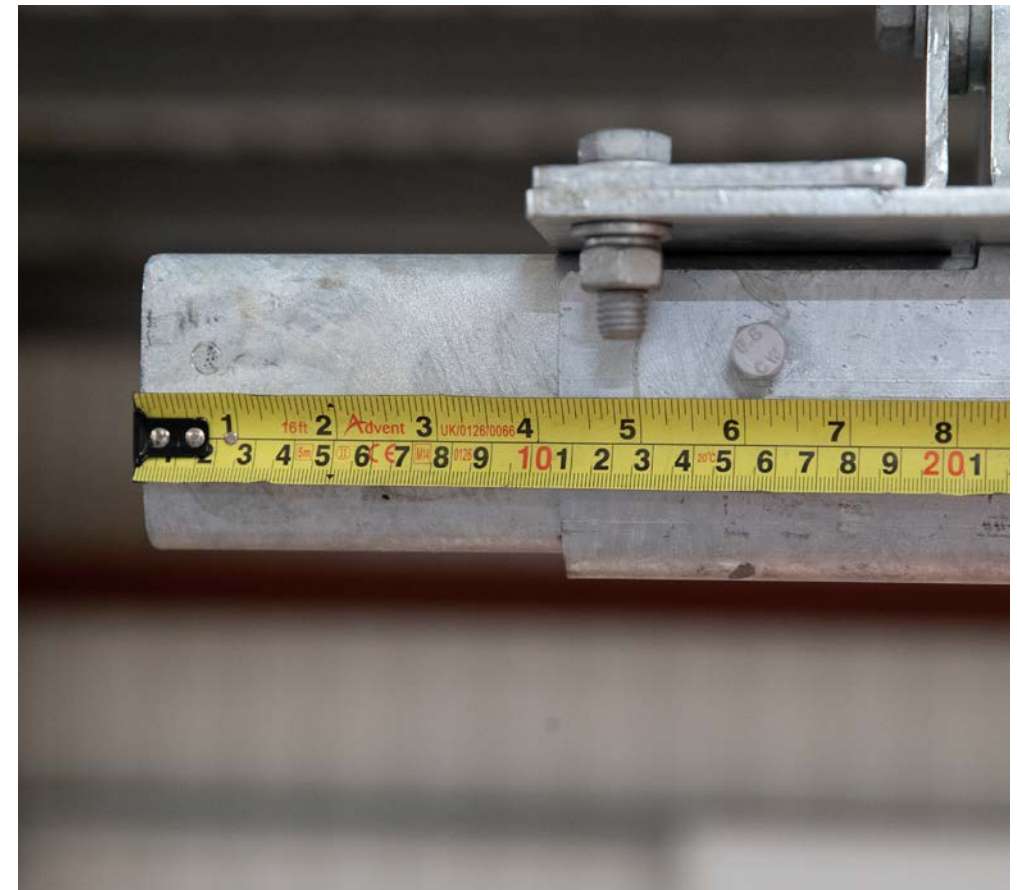

6.6 Rail Joining and Bracing

Step 2

Add splice to existing installed rail, tighten pinch bolts evenly on that half only. Hang additional rail, insert into splice and finally tighten remaining bolts to specified torque to join both sections of rail together.

Note: It is imperative that the bolts are done evenly and the rail sits centrally within the splice to ensure smooth traveller operation.

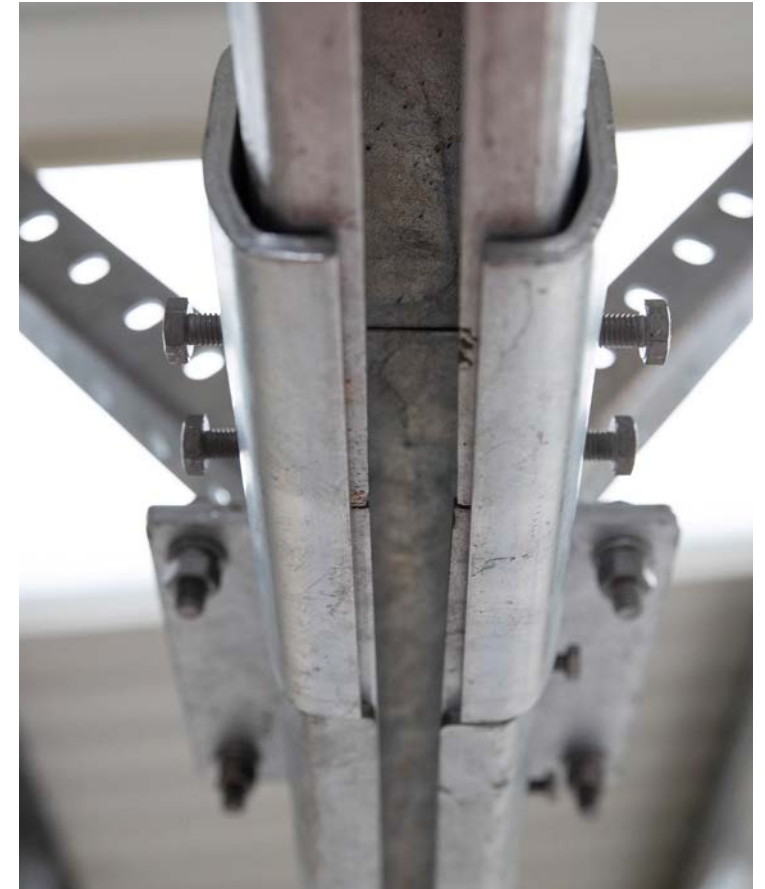

Step 3

For rails installed parallel with purlins, an additional bracing strap must be added between the hangar brackets.

From the table, identify the hangars required, and attach to either side of the hanging brackets.

In the example shown below, the brace (XY) required for this location would need 2 x TLA2000 + 1 x TLA1000 pieces set at the value in the green block in column F to span the hanging brackets.

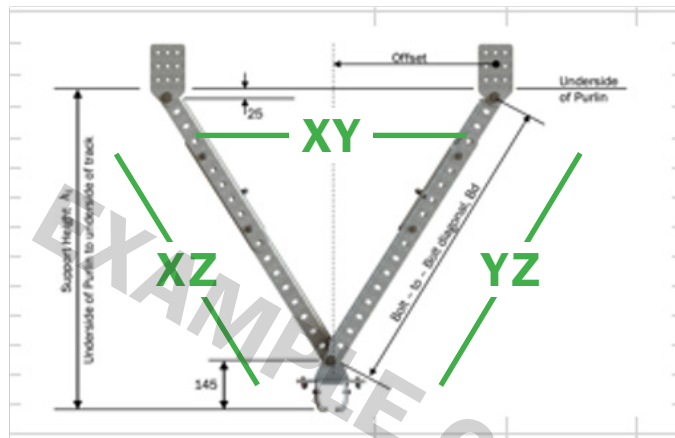

	D	E	F	
Results	Install Values	Link Arms	Theoretical Values	Installed Arm Angle to vertical
Arm length AC:	3.600 m	2-LA2000	3.615 m	38 deg
Arm length BC:	4.100 m	2-LA2000+1-LA1000	4.102 m	33 deg
Bridging AB:	4.300 m	2-LA2000+1-LA1000	4.313 m	



6.6 Rail Joining and Bracing

Step 4

Bring stiffeners together to form horizontal brace section. Where the brace parts join, ensure there is a minimum of three hole overlap and secure with a minimum of two M10 x 40mm fixings. Tighten to torque specified in table.



5.7 Finalising the System

Step 1

Install 10TR600 trolley onto the open end of the rail section.



Step 2

Install the KTESTOP040 end stop buffer assembly to the end of the rail section.



Step 3

Install the Kee Track branding sticker to the end of the rail section.



6.7 Finalising the System

Ensure all fixings are tightened to torque specified along the full length of the system.

Check for smooth operation of traveller.

Complete and attach the system tag to a component that connects the user to the system and ensure it is always accessible to the user before they use the system.

Track install is now complete.

Note: The example tag below is metric. An imperial version is also available.

User Weight Range
45–140 kg

Type of Use
Fall Arrest

Maximum
users

Minimum Deck Height
2.0 m

Authorised
Users only

Read
Instructions Before Use

6 kN per user
Maximum Arrest Force

Inspect
Apparatus Before Use

Keep Track®
Keep Safety

Installation Date **System Number**

Inspection Date

System Status

	Pass	Conditional Pass	Conditional Fail	Fail
<input type="text"/>	<input type="text"/>	<input type="text"/>	<input type="text"/>	<input type="text"/>
<input type="text"/>	<input type="text"/>	<input type="text"/>	<input type="text"/>	<input type="text"/>
<input type="text"/>	<input type="text"/>	<input type="text"/>	<input type="text"/>	<input type="text"/>
<input type="text"/>	<input type="text"/>	<input type="text"/>	<input type="text"/>	<input type="text"/>

Scan QR Code For Full System Information

Keep Track®
Keep Safety



7. KEE TRACK - INSPECTION

It is required that a record be kept for each Kee Track System. The record should contain headings for and spaces to allow entry of at least the details shown below:

Periodic inspections by a competent person are recommended by the manufacturer. In UK/ Europe these are required under:

- a) Workplace (Health, Safety & Welfare) Regulations – Regulation 5
- b) The Work at Height Regulations 2005 (Regulation 12)
- c) BS EN 365 Personal protective equipment against falls from a height — General requirements for instructions for use, maintenance, periodic examination, repair, marking and packaging
- d) BS 7883 2019 Personal fall protection equipment - Type D Anchor systems - System design installation and inspection - code of practice

The frequency will depend upon the environment, location and usage but should be at least every 12 months:

- Signage/labelling is present, legible, and positioned at all access/egress locations;
- Structural connections are in accordance with the manufacturer's recommendation and PFPS design;
- Support bracket/hanger centres (span) do not exceed the manufacturer's recommendation;
- Set screws/bolts are present and torque set as per manufacturer's recommendations;
- Component integrity and inspect for signs of missing components;
- Track joiners are correctly positioned centrally (x3 set screws per track section);
- Shuttle/traveller (one per user) runs freely along the track;
- Remove shuttle/traveller from fall protection system and inspect the condition and functionality, including:

- a) Rollers
- b) Circlip & pin
- c) Stress fractures and cracks
- d) Bending and deformation
- e) General corrosion

- Clean shuttle/traveller as recommended by manufacturer
- Clean interface between track and shuttle/traveller as appropriate (e.g. dusty environments)
- End stops are present and incorporate nylon bushing
- Corrosion - inspection of all components
- Components for any signs of damage/splitting/cracking
- Track does not cantilever more than 500mm / 1'8" beyond the extremity hangers/brackets
- Overlapping hanger arms shall incorporate x2 bolt sets at each overlap extremity (x4 bolt sets in total)
- Overlapping horizontal braces shall incorporate x2 bolt sets at the central overlap;
- Update signage/labelling to reflect PFPS status and next inspection due date;

Equipment record example

Name: Kee®Track Model 1/1	Type: Rigid Anchor Line (Track) to:
Name & Address of Authorised Agent Kee Safety Ltd Cradley Business Park Overend Road Cradley Heath B64 7DW	System Ref/Number ***** Year of manufacture ***** Purchase date ***** Inspection date prior to first use *****
Other compatible components to be used	Other Compatible components to be used
EN 361 - Full body harnesses	OSHA 1926.502 (d)(18) - Full body harnesses ANSI Z359.11-2014 - Safety Requirements for Full Body Harnesses CSA Z259.10-2018 - Full Body Harnesses
EN 360 - Self retractable type fall arresters	OSHA 1926.502 (d)(12) - Self retractable type fall arresters
	ANSI Z359.14-2014 - Safety Requirements For Self-Retracting Devices For Personal Fall Arrest And Rescue Systems
	Z259.2.2-17 - Self-Retracting Devices
Record of use	Record of use

8. GENERAL INFORMATION

Transportation

Kee Track components are of robust construction. While care should be taken during transportation not to cause any damage to them, special packaging is not required.

Markings on the products and their meaning

Various markings can be found on Kee Track components. Always check the legibility of the product markings. The meaning of these markings is as follows:

Marking	Meaning
Kee Safety Ltd	The supplier of Kee Track
Rigid Anchor Line (Track)	Type of Fall Protection System
03.21	Date & Batch Number for ease of traceability
EN 795:2012 Type D	Kee Track conforms to EN 795:2012
CEN TS 16415	Kee Track conforms to CEN TS 16415
BS8610:2017	Kee Track conforms to BS8610:2017
ANSI Z359.6-2016	Kee Track conforms to ANSI Z359.6-2016
CSA Z259.16-15	Kee Track conforms to CSA Z259.16-04
Users must read and understand the instructions for use for this product	Users should be fully conversant with the instructions for use before using this product. Always follow the warnings and instructions for use

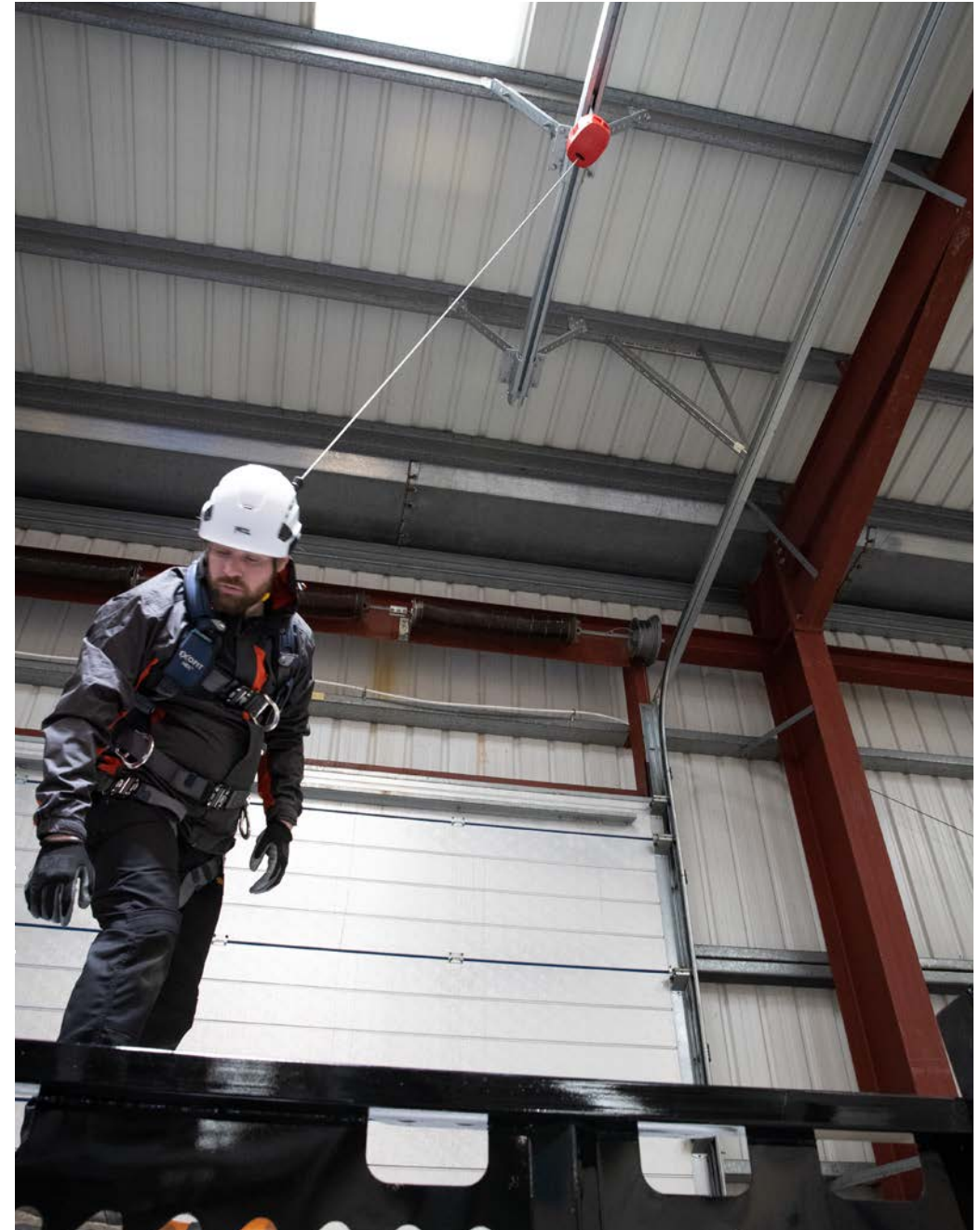

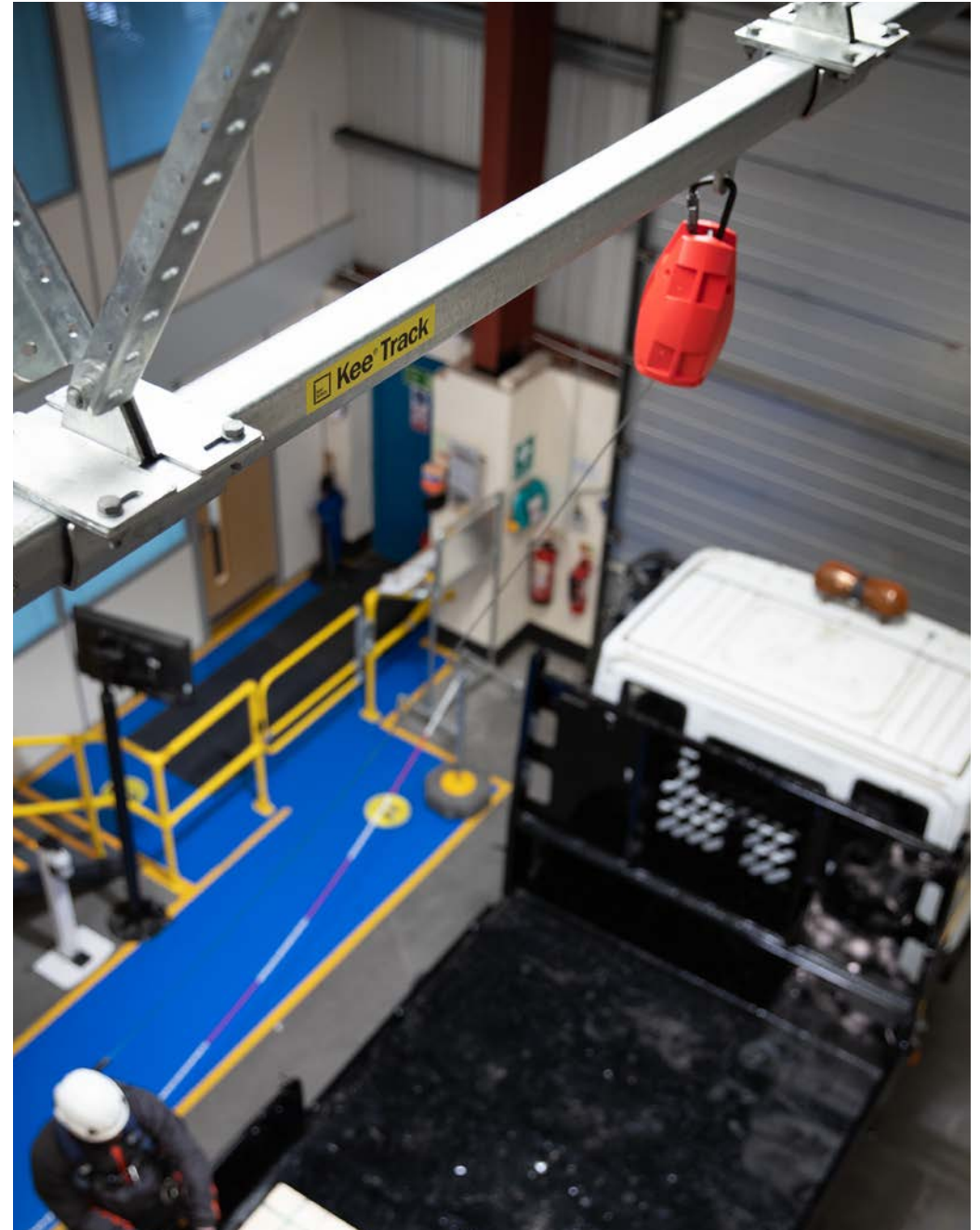

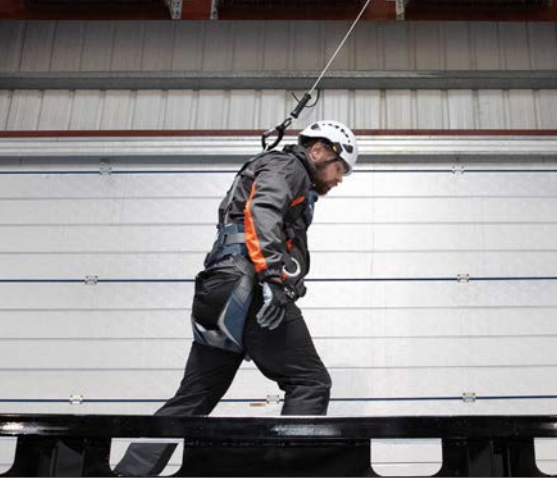

Kee Safety LLC
Dubai Investment Park Near
Green Community
PO Box 18448
Dubai
United Arab Emirates

Tel: +971 4 885 9066
Email: uaesales@keesafety.com
Web: www.keesafety.ae

KEE TRACK is a registered trademark of Kee Safety Limited. Whilst every effort has been made to ensure the accuracy of the information contained in this brochure Kee Safety Group Ltd and/or its subsidiaries cannot be held responsible for any errors or omissions. Kee Safety Group Ltd, it's affiliates and subsidiaries reserve the right to alter or withdraw products without prior notice. Kee Safety Group Ltd and/or its subsidiaries accepts no responsibility for any loss or damage arising from improper use of their products.
©2021 Kee Safety Limited Ltd. All Rights Reserved.